

OWNER'S MANUAL

MAGNAVOX
Smart. Very smart.®

MC194EMG
COLOR TV WITH BUILT-IN VCR



NEED HELP? CALL US!

MAGNAVOX REPRESENTATIVES ARE READY TO HELP YOU WITH ANY QUESTIONS ABOUT YOUR NEW PRODUCT. WE CAN GUIDE YOU THROUGH CONNECTIONS, FIRST-TIME SETUP, AND ANY OF THE FEATURES.

WE WANT YOU TO START ENJOYING YOUR NEW PRODUCT RIGHT AWAY.

CALL US BEFORE YOU CONSIDER RETURNING THE PRODUCT.

1-800-705-2000

OR VISIT US ON THE WEB AT WWW.MAGNAVOX.COM



IMPORTANT!

RETURN YOUR WARRANTY REGISTRATION CARD WITHIN 10 DAYS.

SEE WHY INSIDE.

Return your Warranty Registration card today to ensure you receive all the benefits you're entitled to.

Once your MAGNAVOX purchase is registered, you're eligible to receive all the privileges of owning a MAGNAVOX product. So complete and return the Warranty Registration Card enclosed with your purchase at once. And take advantage of these important benefits.

Warranty Verification

Registering your product within 10 days confirms your right to maximum protection under the terms and conditions of your MAGNAVOX warranty.

Owner Confirmation

Your completed Warranty Registration Card serves as verification of ownership in the event of product theft or loss.

Model Registration

Returning your Warranty Registration Card right away guarantees you'll receive all the information and special offers which you qualify for as the owner of your model.

Congratulations on your purchase, and welcome to the "family!"



Dear MAGNAVOX product owner:

Thank you for your confidence in MAGNAVOX. You've selected one of the best-built, best-backed products available today. And we'll do everything in our power to keep you happy with your purchase for many years to come.

As a member of the MAGNAVOX "family," you're entitled to protection by one of the most comprehensive warranties and outstanding service networks in the industry.

What's more, your purchase guarantees you'll receive all the information and special offers for which you qualify, plus easy access to accessories from our convenient home shopping network.

And most importantly you can count on our uncompromising commitment to your total satisfaction.

All of this is our way of saying welcome-and thanks for investing in a MAGNAVOX product.

P.S. Remember, to get the most from your MAGNAVOX product, you must return your Warranty Registration Card within 10 days. So please mail it to us right now!

Know these **safety** symbols



⚡ This "bolt of lightning" indicates uninsulated material within your unit may cause an electrical shock. For the safety of everyone in your household, please do not remove product covering.

! The "exclamation point" calls attention to features for which you should read the enclosed literature closely to prevent operating and maintenance problems.

WARNING: TO PREVENT FIRE OR SHOCK HAZARD, DO NOT EXPOSE THIS EQUIPMENT TO RAIN OR MOISTURE.

CAUTION: To prevent electric shock, match wide blade of plug to wide slot, fully insert.

ATTENTION: Pour éviter les choc électriques, introduire la lame la plus large de la fiche dans la borne correspondante de la prise et pousser jusqu'au fond.

For Customer Use

Enter below the Serial No. which is located on the rear of the cabinet. Retain this information for future reference.

Model No. _____

Serial No. _____

Visit our World Wide Web Site at <http://www.magnavox.com>

Welcome to your TV/VCR owner's manual, which describes these features.

Features

- Automatic Channel Setup
- Automatic Head Cleaner
- Automatic Tracking Adjustment
- Closed Caption
- Daylight-Savings Time
- English or Spanish displays and menus
- High Quality (HQ) System
- One-Touch Recording
- Remote Control or Front Panel menu access
- Rental Playback
- Repeat Play
- ShowGuard™ - Indefinite Timer Recording memory
- Sleep Timer
- Special Effects: Forward and Reverse Searching; Still; Slow, Frame Advance
- Search: Index, Time
- Tape Counter
- Timer Recording
- Wake Up Timer
- Zero Return

Safety Precautions

Warning: To prevent fire or shock hazard, do not expose this equipment to rain or moisture.

Federal Communications Commission (FCC) Warning: Any unauthorized changes or modifications to this equipment void the user's authority to operate it. This equipment has been tested and found to comply with the limits for a Class B digital device, pursuant to Part 15 of the FCC Rules. These limits are designed to provide reasonable protection against harmful interference in a residential installation. This equipment generates, uses, and can radiate radio frequency energy and, if not installed and used in accordance with the instructions, may cause harmful interference to radio communications.

However, there is no guarantee that interference will not occur in a particular installation. If this equipment does cause harmful interference to radio or television reception, which can be determined by turning the equipment off and on, the user is encouraged to try to correct the interference by one or more of the following measures:

1. Reorient or relocate the receiving antenna.
2. Increase the separation between the equipment and receiver.
3. Connect the equipment into an outlet on a circuit different from that to which the receiver is connected.
4. Consult the dealer or an experienced radio/TV technician for help.

Magnavox recommends you use only videotapes that have the **VHS** mark. Other tapes may cause poor picture quality and excessive deposits on the video heads that the warranty may not cover if damage occurs.

This TV/VCR has a High Quality (HQ) system and is compatible with existing Video Home System (VHS) equipment.

Note to the Cable TV System Installer: This reminder calls the Cable TV system installer's attention to Article 820-40 of the National Electrical Code, which provides guidelines for proper grounding – in particular, specifying that the cable ground shall be connected to the grounding system of the building, as close to the point of cable entry as possible.

Declaration of Conformity

Model Number: MC194EMG
Trade Name: Magnavox
Responsible Party: Philips Consumer Electronics
P.O. Box 14810
Knoxville, TN 37914-1810
(865) 521-4316



As an ENERGY STAR® Partner, Magnavox has determined that this product meets the ENERGY STAR® guidelines for energy efficiency. ENERGY STAR® is a U.S. registered mark. Using products with the ENERGY STAR® label can save energy. Saving energy reduces air pollution and lowers utility bills.

ShowGuard™ is a trademark of Philips Consumer Electronics.

Copyright 2003 Magnavox. All rights reserved.

4 Table of Contents

First-time Setup

| | |
|--|-----|
| Introduction | 3 |
| Table of Contents | 4 |
| Before Using the TV/VCR | 5 |
| Hooking Up the TV/VCR | 6-7 |
| Setting TV Channels for the First Time | 8 |

Basic Operations

| | |
|---------------------|----|
| Playing a Videotape | 9 |
| Recording | 10 |

Basic Controls

| | |
|----------------|----|
| Remote Control | 11 |
| Front Panel | 12 |
| Rear Panel | 13 |

Additional Setup Features

| | |
|--------------------------------------|-------|
| Menu Language, Resetting TV Channels | 14 |
| Adding/Deleting Channels | 15 |
| Setting the Clock | 16-19 |
| Daylight-Savings Time | 20 |
| Status Displays, Picture Control | 21 |

Recording Options

| | |
|--------------------------------|-------|
| Timer Recording | 22-24 |
| Timer Recording Auto Return | 25 |
| Rerecording (Tape Duplication) | 26 |
| One-Touch Recording | 27 |

Playing Options

| | |
|------------------------------|----|
| Playback Options | 28 |
| Repeat Play | 29 |
| Rental Playback, Zero Return | 30 |
| Time Search, Index Search | 31 |

Additional Features

| | |
|------------------------------|-------|
| Setting V-Chip | 32-34 |
| Closed Caption | 35 |
| Wake Up Timer | 36 |
| Sleep Timer | 37 |
| Automatic Operation Features | 38 |

Information You May Need

| | |
|------------------|-------|
| Glossary | 39 |
| Helpful Hints | 40-41 |
| Specifications | 42 |
| Limited Warranty | 43 |
| Index | 44 |

Before Using the TV/VCR 5

Putting Batteries in the Remote Control

- 1** Remove the battery compartment lid on the bottom of the remote control by sliding the lid down and off, following the direction of the arrow on the lid.
- 2** Place two AA batteries inside the battery compartment with their + and - ends aligned as indicated.
- 3** Replace the battery compartment lid.

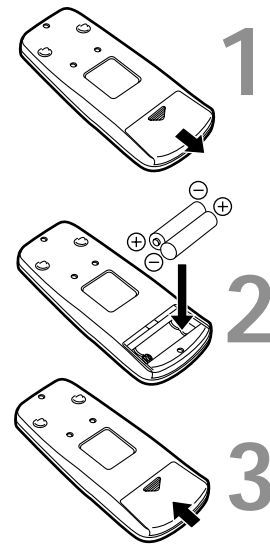

Battery Safety

Battery Usage CAUTION - To prevent battery leakage that may result in bodily injury, property damage, or damage to the unit:

- Install ALL batteries correctly, with the + and - markings on the battery aligned as indicated on the unit;
- Do not mix batteries, for example, old with new or carbon with alkaline; and
- Remove batteries when the unit will not be used for a long time.

Recording Prevention

Videotapes have record tabs to ensure you do not erase recordings accidentally.

- 1** To prevent accidental recording, break off the tab with a screwdriver. You cannot record on the videotape if the tab is missing.
- 2** To record again on the same videotape, cover the hole with cellophane tape.

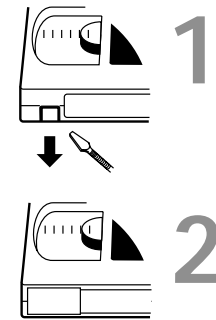

Using the Remote Control

- Point the remote control at the front of the TV/VCR.
- Do not put objects between the remote control and the TV/VCR.

TV/VCR Maintenance

- In this TV/VCR, use only tapes with the **VHS** mark.
- Remove any light adhesive stick-on notes from the videotape before putting the tape in the TV/VCR. Removable labels can jam the TV/VCR.
- The TV/VCR requires periodic maintenance to maintain its excellent performance. This TV/VCR has an internal automatic head cleaning system. However, the video heads will eventually require cleaning or replacement. Only an authorized service center should perform this service.

Helpful Hint

- Your new product, its packaging, and this manual contain materials that can be recycled and reused. Specialized companies can recycle your product to increase the amount of reusable materials and to minimize the amount that needs to be properly disposed. Your product uses batteries that should not be thrown away when depleted but should be disposed of as small chemical waste. Please find out about the local regulations on disposal of your old product, batteries, manual, and packaging when you replace existing equipment.

6 Hooking Up the TV/VCR

1 Hook up your TV/VCR using one of the connections shown.

A Hooking Up Your TV/VCR With a Cable TV Signal or Outdoor Antenna

Connect a Cable TV signal or an antenna to the ANT(enna) Jack.

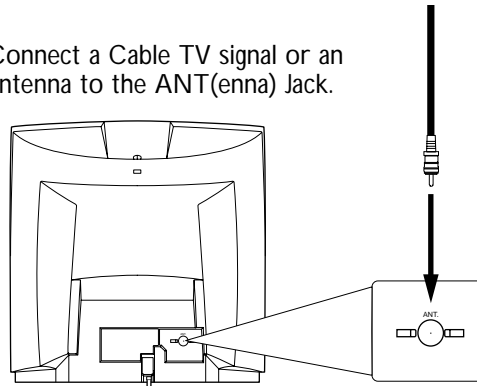

B Hooking Up Your TV/VCR With a Cable Box/Satellite Receiver

To view any channel, set the TV/VCR to the Cable Box/Satellite Receiver output channel (channel 03 or 04). Then, select channels at the Cable Box/Satellite Receiver.

Connect the Cable TV/Satellite signal to the IN Jack on the Cable Box/Satellite Receiver.

Connect an RF coaxial cable (75-ohm, not supplied) to the OUT Jack on the Cable Box/Satellite Receiver and to the ANT(enna) Jack on the TV/VCR.

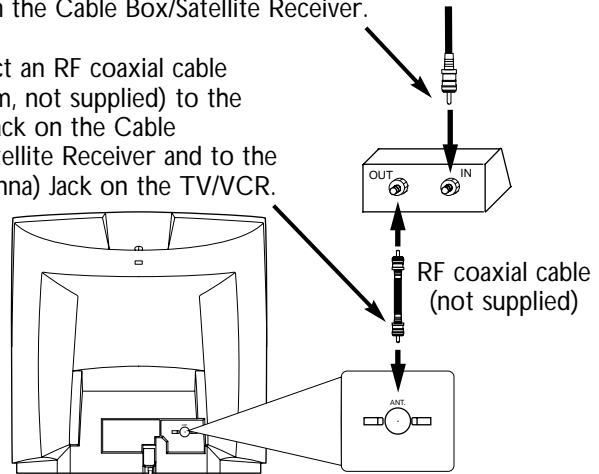

C Hooking Up Your TV/VCR With an Indoor Antenna

To install a rod antenna (not supplied), push the stem of the antenna into the antenna hole at the top on the rear of the TV/VCR. Connect the antenna wire to the ANT(enna) Jack on the rear of the TV/VCR as shown. Extend the antenna and adjust its length, direction, and angle for the clearest picture.

Rod Antenna
(not supplied)

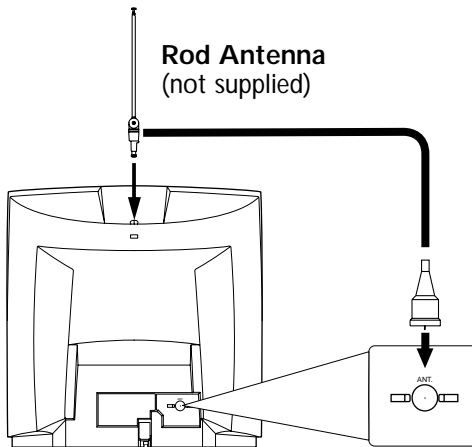

Instructions continue on the next page.

Hooking Up the TV/VCR (cont'd) 7

D Hooking Up Your TV/VCR to Another Video Source (VCR, Camcorder, DVD Player, etc.)

You may need this connection if you want to copy tapes, view tapes playing on a VCR or Camcorder, or view Discs from a DVD Player. Select channel 00 (AUX) at the TV/VCR when viewing tapes/Discs playing on the VCR, Camcorder, or DVD Player.

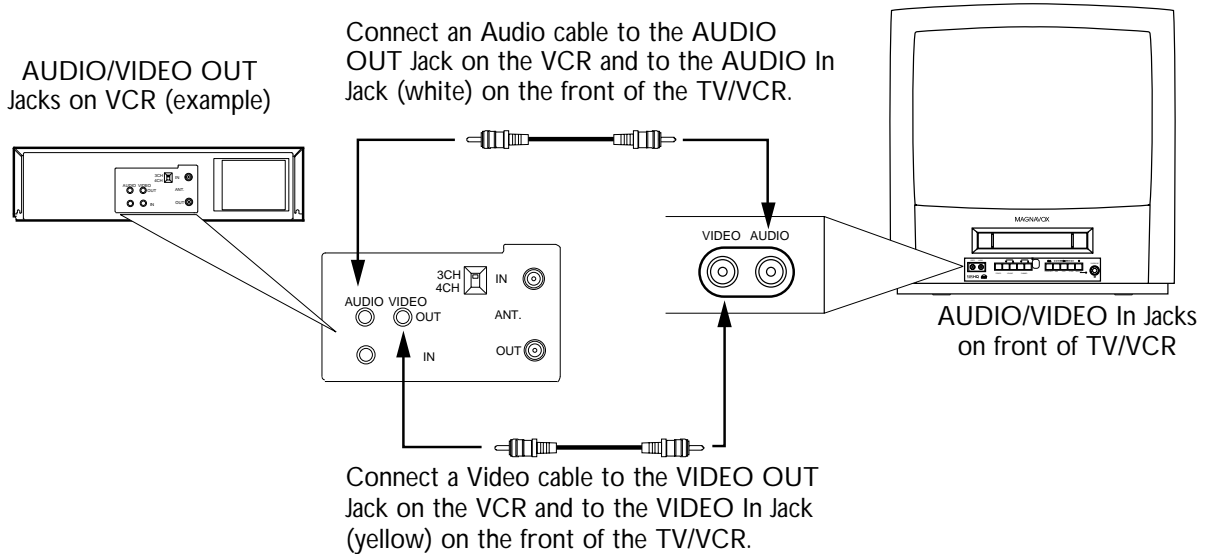

2 When all connections are complete, plug in the TV/VCR's power cord.

3 Follow the steps on page eight when you turn on the TV/VCR for the first time.

Helpful Hints

- Audio and video cables are not supplied. If your VCR, Camcorder, or DVD Player has red and white audio jacks, connect only the white jacks. Or, purchase an audio cable that converts stereo to mono (monaural). It will have red and white plugs on one end (for the VCR, etc.) and a single white plug on the other end (for the TV/VCR).
- Before connecting an antenna or Cable TV signal to the ANT(enna) Jack, make sure the pin is not bent. If the pin is bent, straighten it as illustrated, then connect the antenna or Cable TV signal to the ANT(enna) Jack.

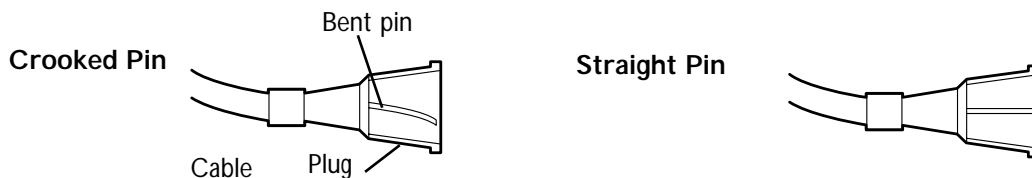

8 Setting TV Channels for the First Time

The TV/VCR can memorize the channels you receive in your area. If you are using a Cable Box or Satellite Receiver, you do not need to set channels at the TV/VCR. Set the TV/VCR to the output channel of the Cable Box or Satellite Receiver (channel 03 or 04). Then select the channel to be viewed on the Cable Box or Satellite Receiver.

If you do not see these menus when you turn on the TV/VCR for the very first time, set TV channels as instructed on page 14 instead.

1 Press **POWER** to turn on the TV/VCR.

2 Press **F.FWD/▶** or **REW/◀** to select **ENGLISH** or **ESPAÑOL (Spanish)**. The selected language will appear inside the [].

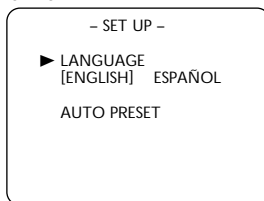

3 Press **PLAY/▲** or **STOP/▼** to select **AUTO PRESET**. Then press **F.FWD/▶**. The TV/VCR scans and memorizes all active channels in your area. (To stop the scanning, press **POWER** to turn the TV/VCR off, then on again.)

When scanning is complete, the TV/VCR will go to the lowest available channel automatically. Use the **CH(annel) ▲/▼** button to select memorized channels. Use the **Number buttons** to select non-memorized channels.

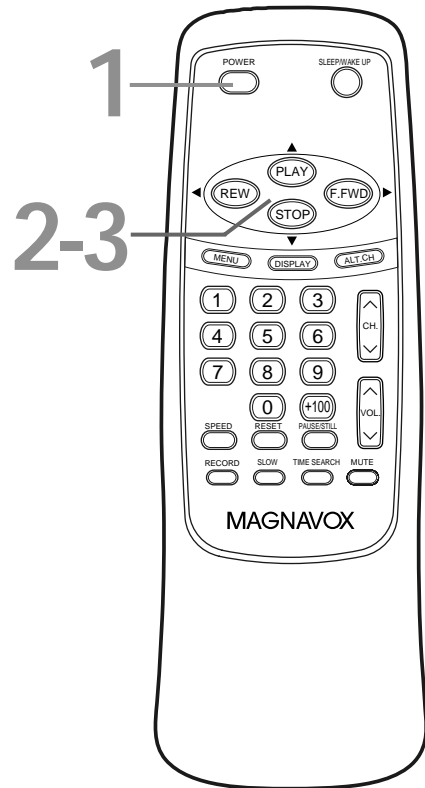
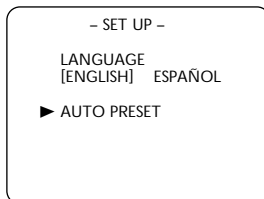

Helpful Hints

- The TV/VCR distinguishes between standard TV channels and Cable TV channels.
- To play or record a videotape before setting TV channels, press the **MENU** button to remove the **SETUP** menu. To set up channels later, see **Resetting TV Channels** on page 14.
- To select Cable TV channels higher than 99, press the **+100** button, then press the **Number buttons** for the last two digits. For example, to select channel 125, press **+100**, **2**, **5**. Precede single-digit channel numbers with a zero (for example, **01 ... 09**).
- You will need to set up the language and channels again after a power failure.

Playing a Videotape 9

Follow the steps below to play a tape.

- 1** Insert a tape in the TV/VCR's cassette compartment. The power will come on. If the tape's record tab is missing, playback should start automatically.

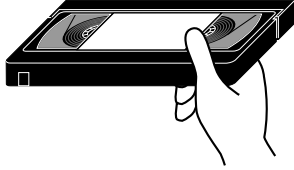

- 2** If playback does not start automatically, press **PLAY/▲** to start playback.

- 3** Press **STOP/▼** to stop playback.

- 4** Press **REW(ind)/◀** to rewind the tape.

- 5** When the tape finishes rewinding, press **STOP/EJECT** on the front of the TV/VCR to remove the tape.

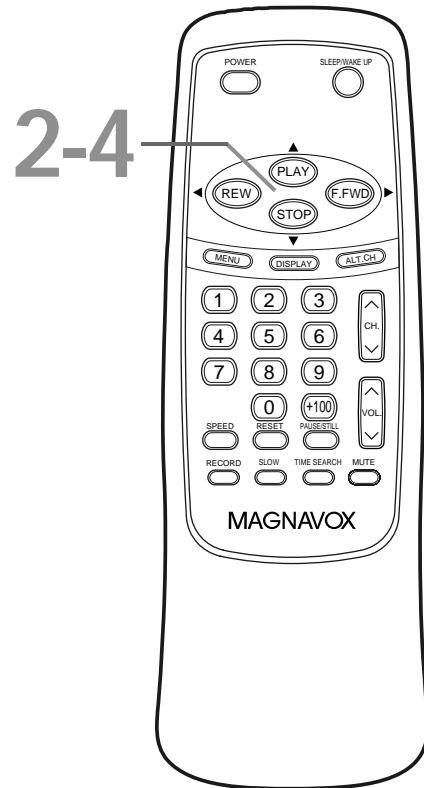

- 5** Press **STOP/EJECT** on the TV/VCR to remove the tape.

Helpful Hints

- If the tape you want to play is already in the TV/VCR, turn on the TV/VCR power, then press **PLAY/▲**.
- Playback features and options are on pages 28-31.
- When you play an S-VHS format tape, you cannot get the high resolution that would be available on an S-VHS VCR. Noise lines (black and white streaks) may appear in the picture.

10 Recording

Follow the steps below to record a current TV program.

- 1** Place a tape with its record tab intact (see page five) in the TV/VCR. The power will come on. Or, if the tape is already in the TV/VCR, press **POWER** to turn on the TV/VCR if necessary.
- 2** Press **SPEED** until the desired tape speed (SP or SLP) appears on the TV/VCR screen. See tape speed details below.
- 3** Use **CH(annel) ▲/▼** or the **Number** buttons to select the channel you want to record. You cannot change channels during recording.
- 4** Press **RECORD** once to start recording. The red Record light will flash on the front of the TV/VCR. If the tape does not have a record tab, the TV/VCR will eject the tape immediately. Insert another tape and try again.
- 5** To pause the recording (for example, during commercials), press **PAUSE/STILL**. To resume recording, press **PAUSE/STILL** again or press **RECORD**.
- 6** To stop recording, press **STOP/▼**.

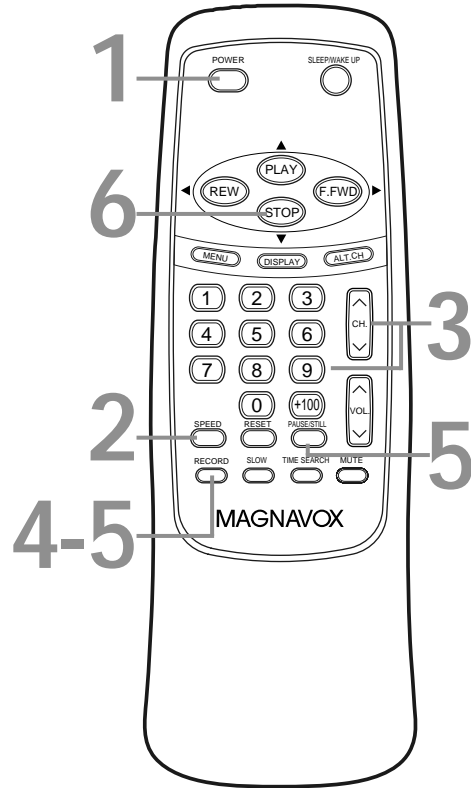

Tape Speeds

This chart shows the recording/playback time for three types of video cassettes (T160, T120, and T60). There are three playback speeds: SP, LP, and SLP. A tape will play only in the speed in which it was recorded. When recording, you can change the tape speed using the **SPEED** button. You cannot record in LP speed on this TV/VCR.

The slower the speed, the more programming you can fit on the tape. SLP is the slowest speed. A faster speed gives better picture quality. SP is the fastest speed.

| Tape Speed | Cassette type / Playback Time | | |
|----------------------------------|-------------------------------|--------|--------|
| | T160 | T120 | T60 |
| SP(Standard Play) | 2 hrs. 40 mins. | 2 hrs. | 1 hr. |
| LP(Long Play) (playback only) | 5 hrs. 20 mins. | 4 hrs. | 2 hrs. |
| SLP(Super Long Play) | 8 hrs. | 6 hrs. | 3 hrs. |

Helpful Hints

- You cannot record one channel while watching another.
- Recording options are on pages 22-27.
- If you pause a recording for more than five minutes, the TV/VCR will resume recording automatically.
- You can change the tape speed with the **SPEED** button while a recording is in progress, but some distortion may appear on the tape.

Remote Control 11

PLAY/▲ Button

Press to play a tape. *Details are on page nine.* Press to select a menu item. Press to enter numbers when setting a timer recording or the clock.

POWER Button

Press to turn on or off the TV/VCR.

REW/◀ (rewind) Button

When tape play is stopped, press to rewind the tape at high speed. During tape play, press to rewind the tape while the picture stays on the screen. *Details are on page 28.* Press to change a menu setting.

F.FWD/▶ (fast forward) Button

When tape playback is stopped, press to fast forward the tape at high speed. During tape playback, press to fast forward the tape while the picture stays on the screen. *Details are on page 28.* Press to select a menu item or to change a menu setting.

Number Buttons

Use to select TV channels. *Details are on page eight.*

SPEED Button

Press to select the recording tape speed (SP or SLP). *Details are on page 10.*

RECORD Button

Press to start a recording. *Details are on page 10.*

RESET Button

Press to reset the tape counter to 0:00:00. *Details are on page 30.*

SLOW Button

During tape playback, press to view the picture in slow motion. *Details are on page 28.*

SLEEP/WAKE UP Button

Press to set the Sleep Timer. *Details are on page 37.* Press to set the Wake Up Timer. *Details are on page 36.*

STOP/▼ Button

Press to stop the tape. Press to select a menu item. Press to enter numbers when setting the clock or a timer recording.

ALT. CH (Alternate Channel) Button

Press to return to the TV channel you were viewing previously.

DISPLAY Button

Press to display the tape status or the current channel number and time on the TV screen. *Details are on page 21.*

MENU Button

Press to display the main menu. Press to remove menus.

CH(annel) ▲/▼ Button

Press to scan through the TV/VCR's available channels.

VOL(ume) ▲/▼ Button

Press to adjust the sound level. Pressing VOL(ume) ▲/▼ when the sound is muted will restore the sound.

MUTE Button

Press to eliminate the TV/VCR's sound. Press again to return to the previous volume level.

TIME SEARCH Button

Press to activate a Time Search. *Details are on page 31.*

PAUSE/STILL Button

Press to pause recording. Press again to resume recording. *Details are on page 10.* During tape playback, press to freeze the picture (still). Press repeatedly to advance the picture one frame at a time. *Details are on page 28.*

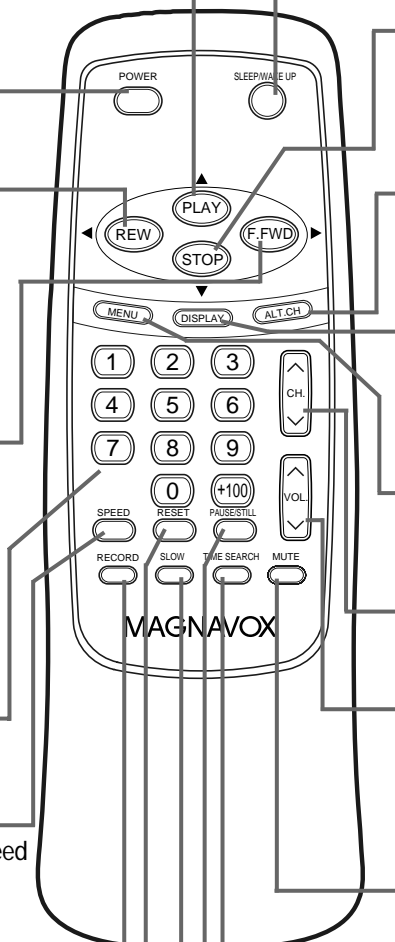

12 Front Panel

Cassette Compartment

Insert a videotape here.

Remote Sensor

Receives a signal from your remote so you can operate the TV/VCR from a distance.

CHANNEL ▲/▼ Buttons

Press to select a TV channel. To access the TV/VCR's menu, press CHANNEL ▲ while in line input (AUX) mode. Press again to remove the menu and go to your lowest TV channel.

Press to adjust the tracking during tape playback. *Details are on page 38.*

VOLUME ▲/▼ Buttons

Press to adjust the sound level. Pressing a VOLUME button while the sound is muted will restore the sound.

VIDEO In Jack

Connect this jack to the video out jack of a Camcorder, VCR, DVD Player, etc.

Details are on pages seven and 26.

AUDIO In Jack

Connect this jack to the audio out jack of a Camcorder, VCR, DVD Player, etc. *Details are on pages seven and 26.*

POWER Button

Press to turn the TV/VCR on or off. Turn off the TV/VCR for a timer recording.

STOP/EJECT Button

Press once to stop the tape. When playback is stopped, press to eject the tape. Press to select an item in the menu.

REW (rewind) Button

When tape play is stopped, press to rewind the tape at high speed. During play, press to rewind the tape while the picture stays on the screen. Press to change a setting of a menu item.

PLAY Button

Press to play a tape. *Details are on page nine.*

F.FWD (Fast Forward) Button

When tape play is stopped, press to fast forward the tape at high speed. During play, press to fast forward the tape while the picture stays on the screen. Press to change a setting of a menu item or to go to the next menu.

REC/OTR (record/one-touch recording) Button

Press once to start a recording. *Details are on page 10.* Press repeatedly to start a One-Touch Recording (an immediate timed recording, 30 minutes to eight hours long) of the current TV channel. *Details are on page 27.*

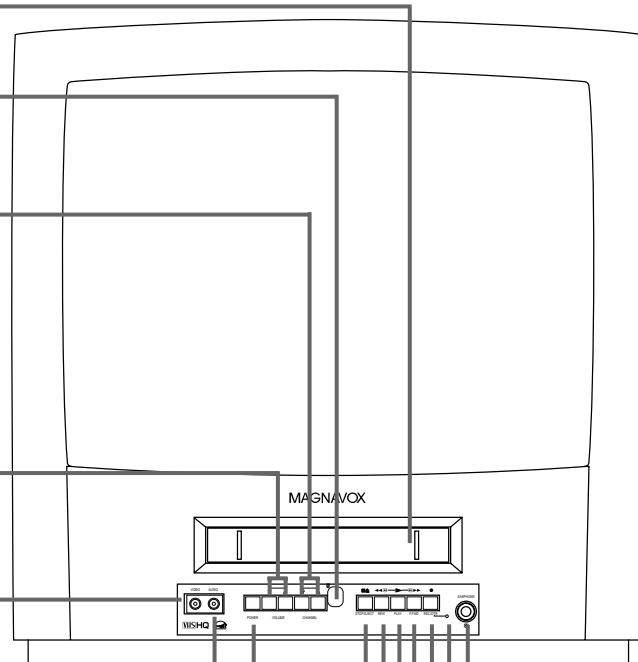

EARPHONE Jack

Connect ear-phones (not supplied) here for personal listening.

Record Light

This light flashes during a recording and when recording is paused. It stays on when the TV/VCR is off for a timer recording.

Rear Panel 13

Antenna Hole

Connect the stem of an indoor rod antenna here. *Details are on page six.*

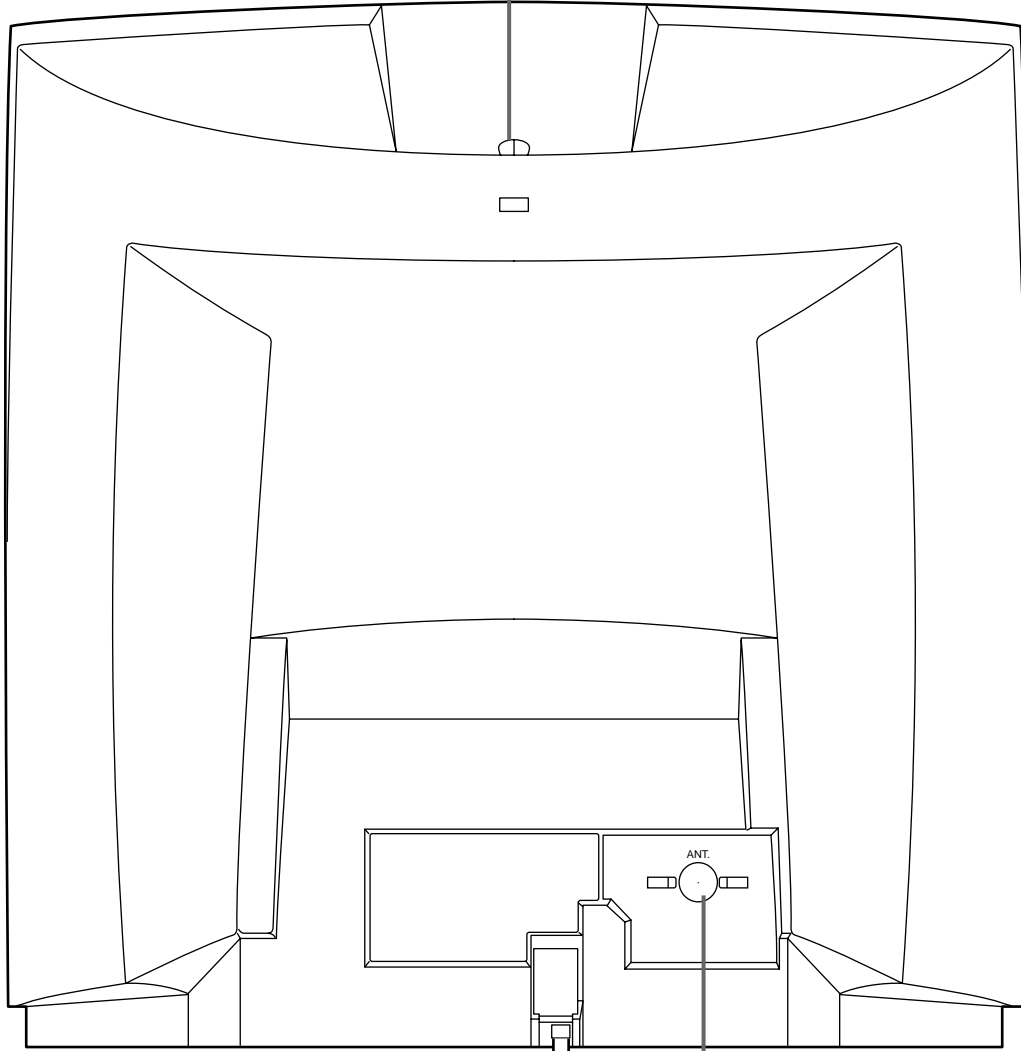

AC Power Cord

Connect to a standard AC outlet to supply power to the TV/VCR.

ANT(enna) Jack

Connect your antenna or Cable TV signal here. *Details are on page six.*

14 Menu Language, Resetting TV Channels

Menu Language

This affects the language of the TV/VCR's menu, not TV programming, videotapes, or closed captioning.

- 1 Press **MENU**. Press **PLAY/▲** or **STOP/▼** to select **LANGUAGE**.

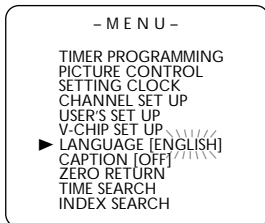

- 2 Press **F.FWD/▶** or **REW/◀** to select **ENGLISH** or **ESPAÑOL** (Spanish).
- 3 Press **MENU** to remove the menu.

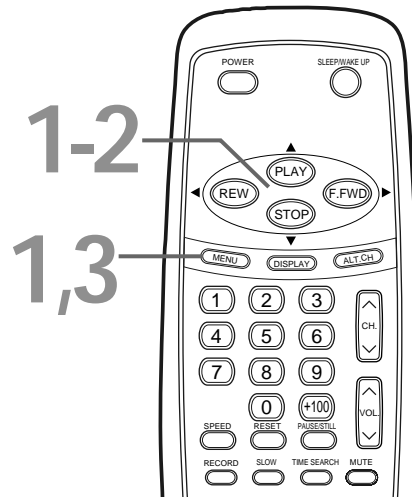

Resetting TV Channels

The TV/VCR may memorize available channels when you turn it on the first time, but you can reset channels.

- 1 Press **MENU**. Press **PLAY/▲** or **STOP/▼** to select **CHANNEL SET UP**. Press **F.FWD/▶**.

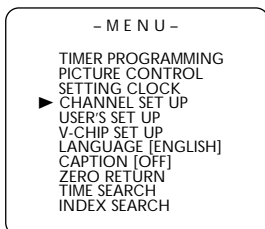

- 2 Press **PLAY/▲** or **STOP/▼** to select **AUTO PRESET**. Then, press **F.FWD/▶**.
The TV/VCR scans and memorizes available channels. When scanning is complete, the TV/VCR will go to the lowest available channel. Press **CH ▲/▼** to select memorized channels. Use the Number buttons to select non-memorized channels.

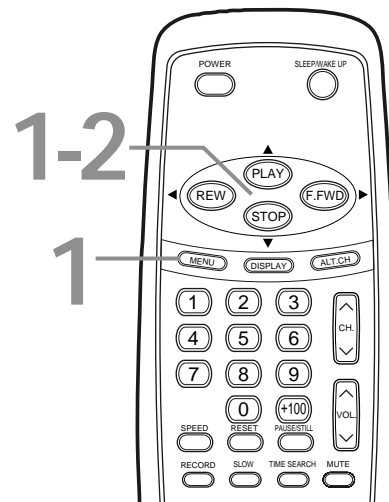
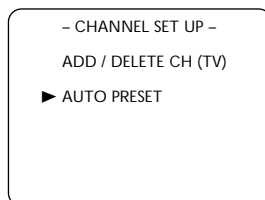

Helpful Hints

- If the menu is in Spanish but you prefer English, press **MENU**, then press **PLAY/▲** or **STOP/▼** to select **IDIOMA ESPAÑOL**, then press **F.FWD/▶** to select **ENGLISH**. Press **MENU** to remove the menu.
- The TV/VCR cannot control or change the channels of a Cable Box or Satellite Receiver.

Adding/Deleting Channels 15

The channels you no longer receive or seldom watch can be deleted from the memory. (Or, you can add new channels into the memory without having to reset all the channels.)

- 1 Press **MENU**. Press **PLAY/▲** or **STOP/▼** to select **CHANNEL SET UP**. Press **F.FWD/▶**.

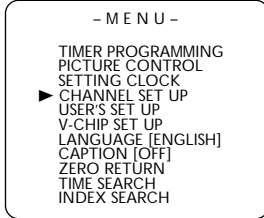

- 2 Press **PLAY/▲** or **STOP/▼** to select **ADD/DELETE CH**. Then, press **F.FWD/▶**.

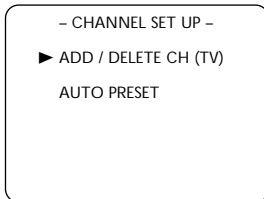

- 3 Press the **Number buttons** to choose a channel you want to add or delete.



- 4 Press **F.FWD/▶** or **REW/◀** to add or delete the channel. Deleted channels will appear in light purple. Added channels will appear in light blue. To delete another channel, repeat steps 3-4.

- 5 Press **MENU** to remove the menu.

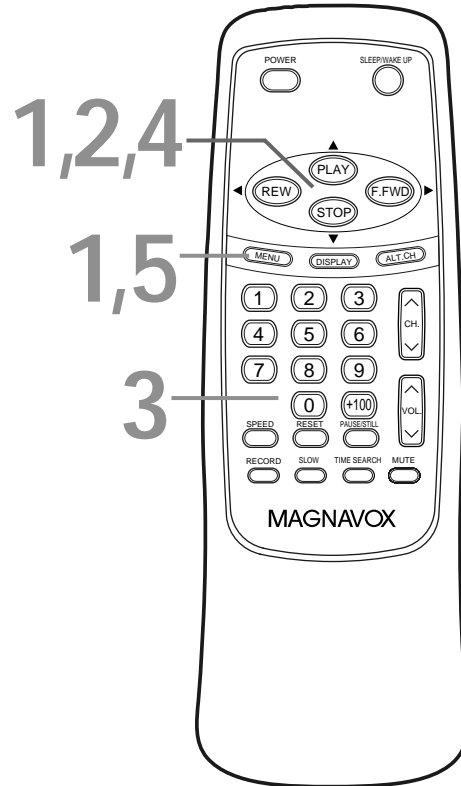

Helpful Hint

- To confirm that a channel has been added or deleted, press the **CH(annel) ▲/▼** button to see if you can or cannot select the channel. Only memorized or added channels can be selected with **CH(annel) ▲/▼**.

16 Setting the Clock

Set the clock accurately for proper timer recording. If a Public Broadcasting Station (PBS) is available in your area, follow Auto Clock Setting below. If not, follow Manual Clock Setting on pages 18-19.

Auto Clock Setting

You can have the TV/VCR set the clock automatically by using the PBS channel in your area. Once you have set the clock, the TV/VCR will automatically monitor the correct time and date being broadcast by PBS and continuously update the time accordingly.

Before you begin, make sure ...

- The TV/VCR power is on.
- The antenna/Cable TV connections are correct.
- The Cable Box is on (if applicable). (See Helpful Hints.)
- Channels are set. *Details are on pages eight and 14.*

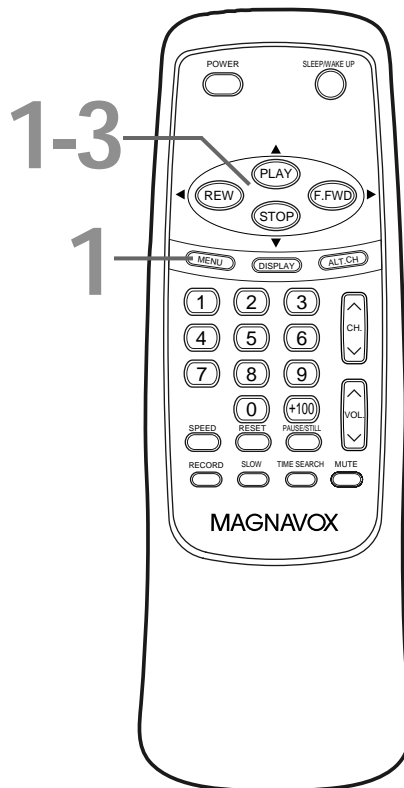

1 Press **MENU**. Press **PLAY/▲** or **STOP/▼** to select **SETTING CLOCK**, then press **F.FWD/▶**.

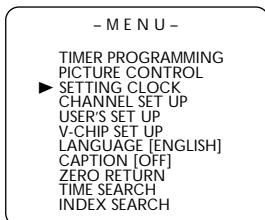

2 With **AUTO CLOCK** selected, press **F.FWD/▶** or **REW/◀** repeatedly until **ON** appears beside **AUTO CLOCK**.

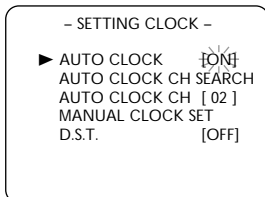

3 If you already know your PBS channel number, skip ahead to step 6 on the next page. If you do not know your PBS channel number, press **STOP/▼** to select **AUTO CLOCK CH SEARCH**, then press **F.FWD/▶**.

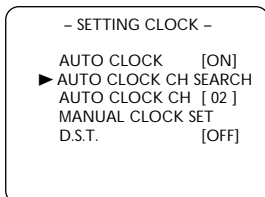

Instructions continue on the next page.

Helpful Hints

- If the TV/VCR is connected to a Cable Box or Satellite Receiver, select the PBS channel on the Cable Box. Set the TV/VCR to the output channel of the Cable Box or Satellite Receiver (usually channel 3 or 4), to set the clock automatically.
- The TV/VCR cannot control or change the channels of the Cable Box or Satellite Receiver.

Setting the Clock (cont'd) 17

The TV/VCR will scan all your available TV channels. Those that carry a time signal will be listed at the top of the screen. Use one of these channels when you enter your AUTO CLOCK CH at step 6. It will take the TV/VCR several minutes to scan the channels. An “_ _” appears in the lower left corner of the screen when the search is complete.

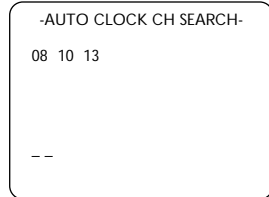

- 4** Press MENU to remove the menu.
- 5** Press MENU. Press PLAY/▲ or STOP/▼ to select SETTING CLOCK, then press F.FWD/▶.
- 6** Press PLAY/▲ or STOP/▼ to select AUTO CLOCK CH. Press F.FWD/▶ or REW/◀ until your PBS channel number appears. Use the channel number you found at step 3.

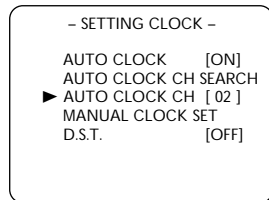

- 7** Press MENU to remove the menu.
- 8** Press POWER to turn off the TV/VCR. The TV/VCR will search for the time only when the power is off. It may take about an hour for the TV/VCR to set the clock.

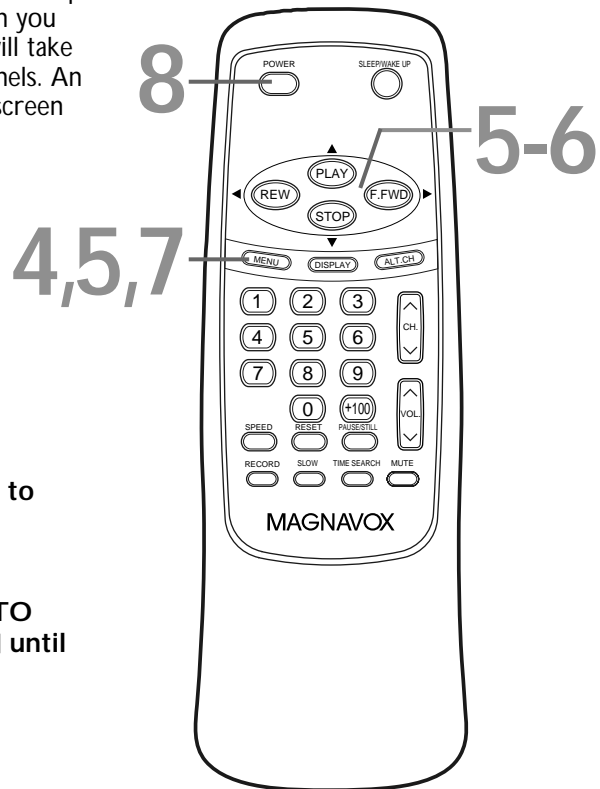

Helpful Hints

- If the TV/VCR sets the time incorrectly, it may have taken the time from a PBS channel in a different time zone. Follow the steps for Manual Clock Setting on pages 18-19.
- If no channel numbers appear during the channel search at step 3, there are no stations in your area that contain the time signal. Use Manual Clock Setting on pages 18-19.
- During the channel search at step 3, the TV picture may be distorted. This is normal.
- To stop the channel search during step 3, press the MENU button.

18 Setting the Clock (cont'd)

Manual Clock Setting

- 1** Press MENU. Press PLAY/▲ or STOP/▼ to select SETTING CLOCK. Then, press F.FWD/▶.

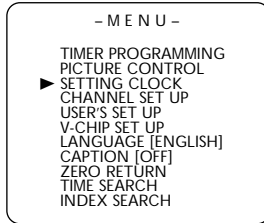

- 2** Press PLAY/▲ or STOP/▼ to select MANUAL CLOCK SET. Then, press F.FWD/▶.

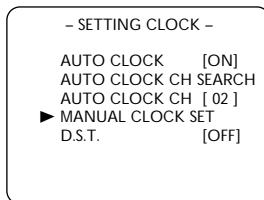

- 3** While the MONTH space is flashing, press PLAY/▲ or STOP/▼ until your desired month appears. (Example: May → 05) Then, press F.FWD/▶.

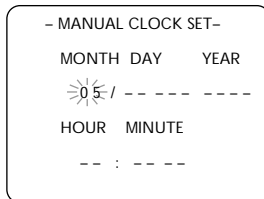

- 4** While the DAY space is flashing, press PLAY/▲ or STOP/▼ until your desired day appears. (Example: 6th → 06) Then, press F.FWD/▶.

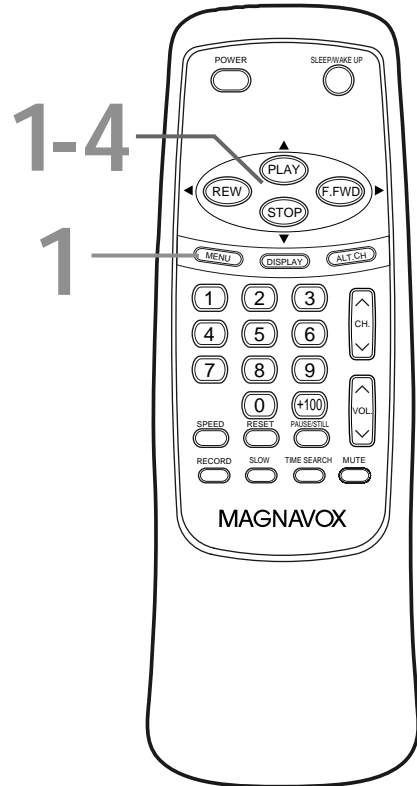
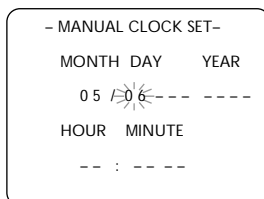

Instructions continue on the next page.

Setting the Clock (cont'd) 19

- 5** While the YEAR space is flashing, press **PLAY/▲** or **STOP/▼** until your desired year appears. (Example: 2003) The day of the week (Tuesday - TUE, etc.) will change appropriately for the year you select. Then, press **F.FWD/▶**.

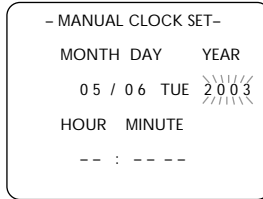

- 6** While the HOUR space is flashing, press **PLAY/▲** or **STOP/▼** until your desired hour and AM or PM appears. (Example: 05 PM) Then, press **F.FWD/▶**.

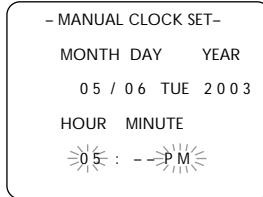

- 7** While the MINUTE space is flashing, press **PLAY/▲** or **STOP/▼** until the desired minute appears. (Example: 40)

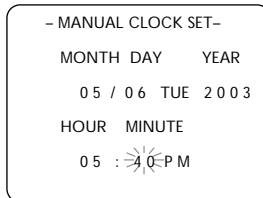

- 8** Press **MENU**. Although seconds are not displayed, they begin counting from zero when you press **MENU**. Use this feature to synchronize the clock exactly.

- 9** To see the current time on the TV screen, press **DISPLAY**. Details are on page 21.

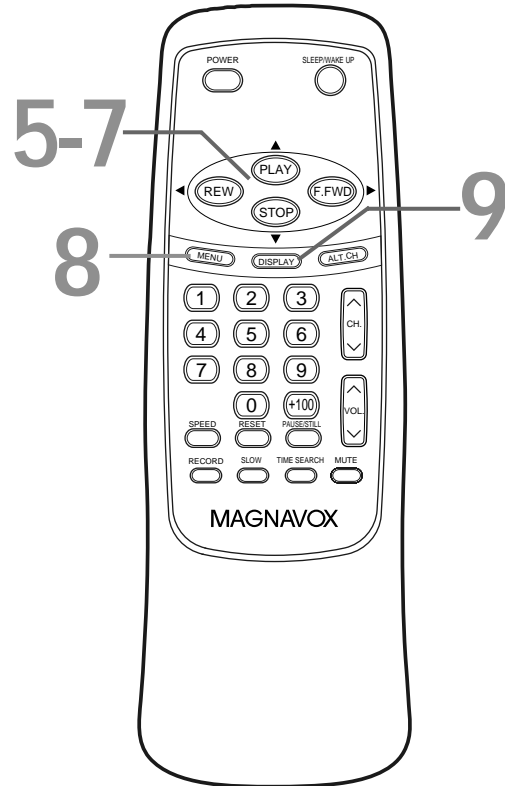
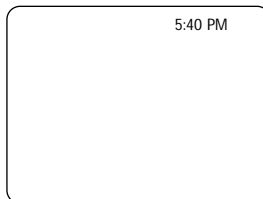

Helpful Hint

- To adjust the clock later, follow steps 1-2 on page 18. Then, press **F.FWD/▶** or **REW/◀** to select the item you want to change. Enter the correct information by pressing **PLAY/▲** or **STOP/▼**. Press **MENU** when you are finished.

20 Daylight-Savings Time

When Daylight-Savings Time (D.S.T.) is ON, the TV/VCR clock will automatically move forward one hour on the first Sunday in April and move back one hour on the last Sunday in October.

To turn Daylight-Savings Time ON or OFF, follow the steps below.

- 1 Press **MENU**. Press **PLAY/▲** or **STOP/▼** to select **SETTING CLOCK**. Then, press **F.FWD/▶**.



- 2 Press **PLAY/▲** or **STOP/▼** to select **D.S.T.**. Then press **F.FWD/▶** until **ON** or **OFF** appears.

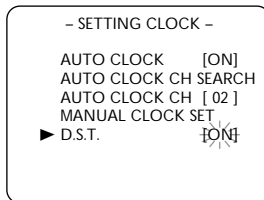

- 3 Press **MENU** to remove the menu.

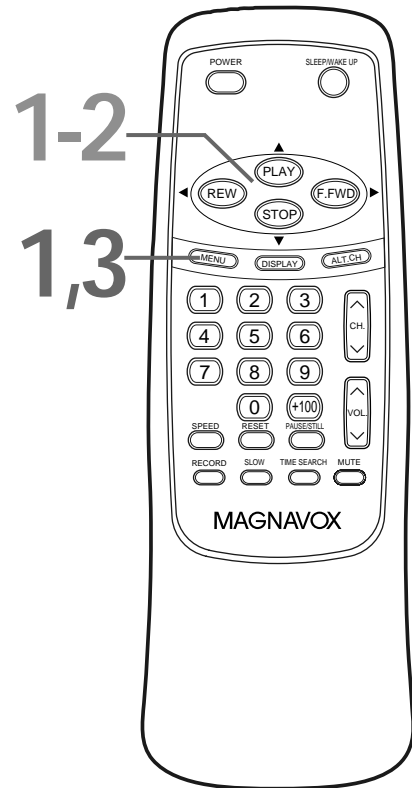

22 Timer Recording

The TV/VCR can record programs while you're away. The TV/VCR will turn itself on, record, and turn itself off.

Before you begin, make sure ...

- The clock is set. If the clock is not set, MANUAL CLOCK SET appears. See pages 18-19 to set the clock, then set the recording.
- Channels are set. *Details are on pages eight and 14.*
- A tape is in the TV/VCR for the recording.

1 Press MENU. Press PLAY/▲ or STOP/▼ to select **TIMER PROGRAMMING**. Press F.FWD/▶.

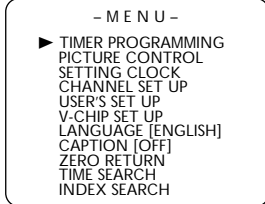

2 Press PLAY/▲ or STOP/▼ to select a program position. Then, press F.FWD/▶.

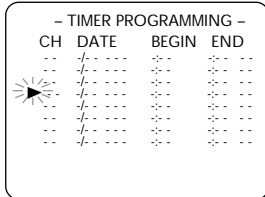

3 Press PLAY/▲ or STOP/▼ until the desired channel number appears. Then press F.FWD/▶. If the TV/VCR is connected to a Cable Box/Satellite Receiver, put the TV/VCR on channel 3 or 4. Set CH as 03 or 04 in the Timer Programming menu. Select the channel to be recorded on the Cable Box/Satellite Receiver. See your Cable Box/Satellite Receiver manual for details.

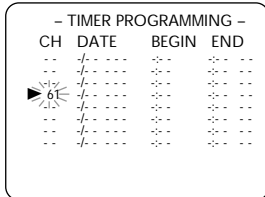

4 The current date will be flashing in the DATE space. For a one-time recording, press PLAY/▲ to select the date you want to record.

To record a TV program at the same time on the same channel every day, press STOP/▼ until EVERY DAY appears. To record a program at the same time, channel, and day of every week, press STOP/▼ until EVERY and the day of the week appear (EVERY MON, etc.). Press F.FWD/▶.

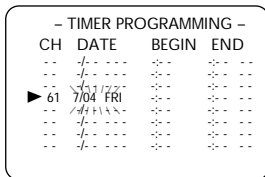

Example:
one-time
recording

Instructions continue on the next page.

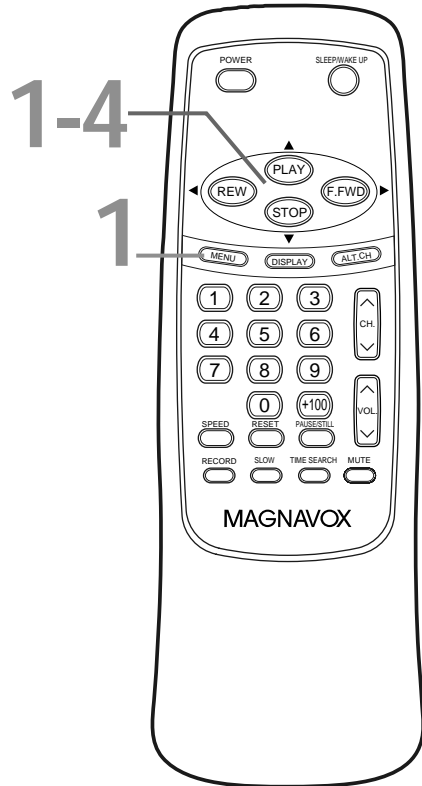

Helpful Hints

- Do not operate the unit during a timer recording.
- If the tape ends before the recording is complete, the TV/VCR will stop recording immediately and eject the tape. The red Record light will come on.
- The red Record light on the TV/VCR will flash while a timer recording is in progress.

Timer Recording (cont'd) 23

5 Press **PLAY/▲** or **STOP/▼** until the beginning hour and AM or PM appears. Press **F.FWD/▶**.

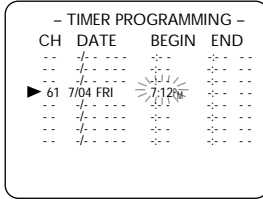

6 Press **PLAY/▲** or **STOP/▼** until the beginning minute appears. Then, press **F.FWD/▶**.

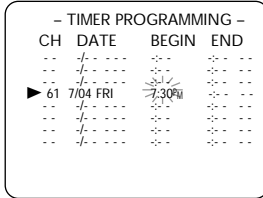

7 Press **PLAY/▲** or **STOP/▼** until the end hour and AM or PM appears. Then, press **F.FWD/▶**.

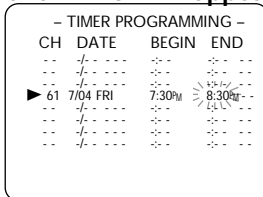

8 Press **PLAY/▲** or **STOP/▼** until the end minute appears. Press **F.FWD/▶**.

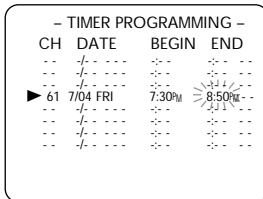

9 Press **PLAY/▲** or **STOP/▼** to choose a tape speed (**SP** or **SLP**).

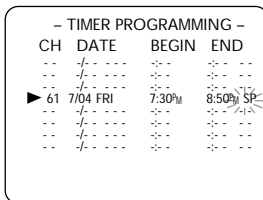

10 Press **MENU** to remove the menu.

11 Press **POWER** to turn off the TV/VCR and set the timer recording. The red Record light on the front of the TV/VCR will appear. You must turn off the TV/VCR for a timer recording. If the power is on, **TIMER REC STANDBY** flashes on the screen two minutes before the recording is scheduled to begin.

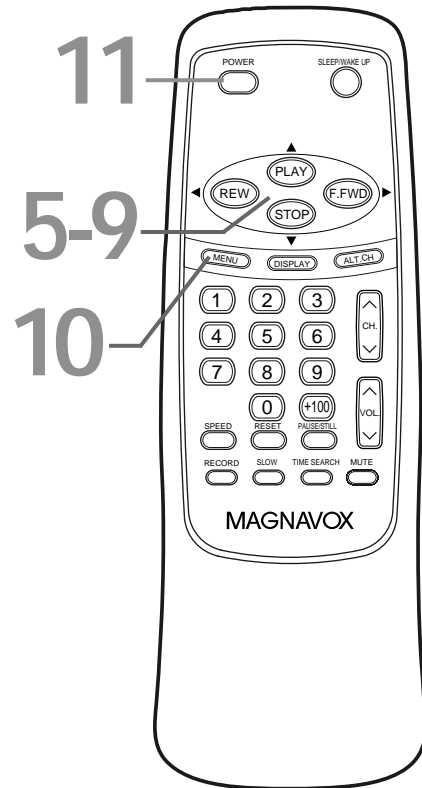

Helpful Hints

- Tape speed details are on page 10.
- With ShowGuard, you don't have to worry about losing your timer recordings. If the power fails, timer recordings will be restored when the clock is reset. The timer recording will not occur if it was scheduled to take place during the power failure.
- The videotape must have its record tab (or tape) intact. If the record tab is missing, the TV/VCR will eject the videotape when you turn off the TV/VCR.

24 Timer Recording (cont'd)

Extending a Timer Recording

To make a Timer Recording start and end later than originally scheduled, follow these steps.

- 1 With the TV/VCR power on, press MENU. Press PLAY/▲ or STOP/▼ to select TIMER PROGRAMMING. Press F.FWD/▶.
- 2 Press RECORD, then press PLAY/▲ or STOP/▼ to select the desired program if necessary.
- 3 Press RECORD again. Each press of RECORD will shift forward the beginning/end time by 10 minutes. If the recording is in progress, only the end time will shift forward and the recording speed will change to SLP.
To restore the original recording times, press PAUSE/STILL.
- 4 Press F.FWD/▶ or REW/◀, then press MENU to remove the menu.
- 5 If the timer recording is scheduled to start later, press POWER to turn off the TV/VCR for the recording.

Correcting Timer Recording Details

- 1 With the TV/VCR on, press MENU. Press PLAY/▲ or STOP/▼ to select TIMER PROGRAMMING. Press F.FWD/▶.
- 2 Press PLAY/▲ or STOP/▼ to select a timer recording, then press F.FWD/▶.
- 3 Press F.FWD/▶ or REW/◀ to select an item. Press PLAY/▲ or STOP/▼ to enter the correct information.
- 4 Press MENU to remove the menu.

Cancelling Timer Recordings

To cancel a timer recording that is in progress:

- 1 Press POWER to turn on the TV/VCR, then press STOP/EJECT on the front of the TV/VCR.

To cancel a timer recording that has not started:

- 1 With the TV/VCR power on, press MENU. Press PLAY/▲ or STOP/▼ to select TIMER PROGRAMMING. Press F.FWD/▶.
- 2 Press PLAY/▲ or STOP/▼ to select a timer recording.
- 3 Press RESET.
- 4 Press MENU to remove the menu.

Checking Scheduled Timer Recordings

- 1 With the TV/VCR on, press MENU. Press PLAY/▲ or STOP/▼ to select TIMER PROGRAMMING.
- 2 Press F.FWD/▶. The program details will appear on the screen.
- 3 Press MENU to remove the menu.

Timer Recording Auto Return 25

Turning on AUTO RETURN sets the TV/VCR to rewind the tape automatically to the beginning of a timer recording.

- 1 Press **MENU**. Press **PLAY/▲** or **STOP/▼** to select **USER'S SET UP**. Then, press **F.FWD/▶**.

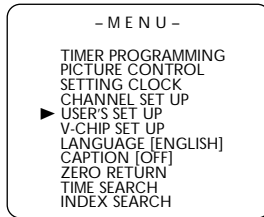

- 2 Press **PLAY/▲** or **STOP/▼** to select **AUTO RETURN**. Press **F.FWD/▶** or **REW/◀** until **ON** appears beside **AUTO RETURN**. To deactivate **AUTO RETURN**, select **OFF**.

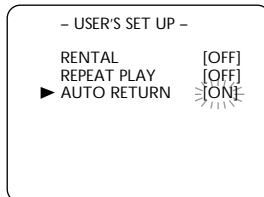

- 3 Press **MENU**. When all timer recordings are completed, the TV/VCR will rewind the current tape to the beginning of the recorded program(s). Press **PLAY/▲** to play the tape from the beginning of the timer recordings.

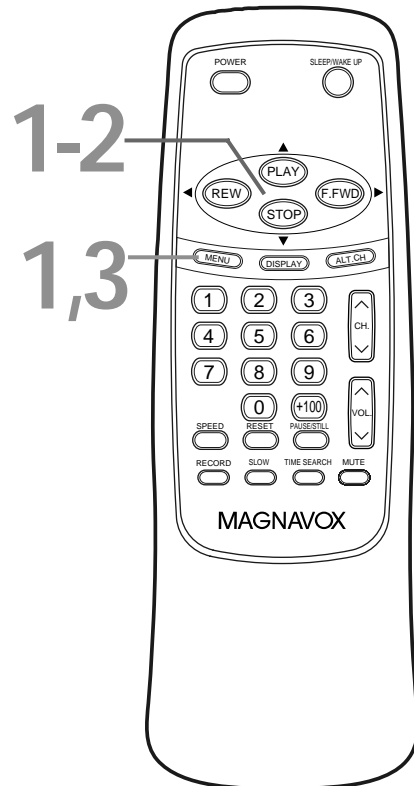

Helpful Hints

- If you press **POWER** while the tape is rewinding, **Auto Return** will stop.
- If there is a power failure, the **TV/VCR** will retain its memory for this feature.

26 Rerecording (Tape Duplication)

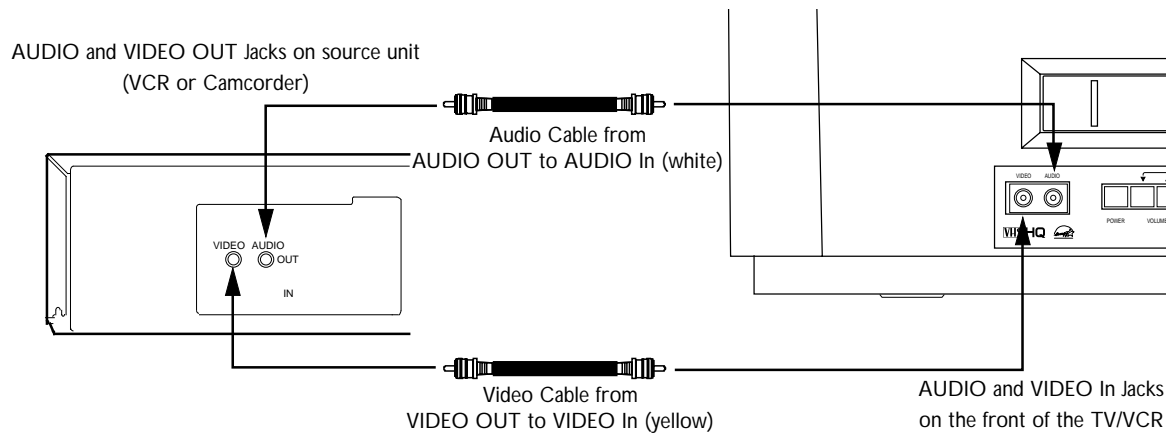

- 1** Make the connections shown above, using audio and video cables (not supplied). Connect the source unit (VCR or Camcorder) to a power source after connections are made.
- 2** The VCR or Camcorder will play your tape. **Insert a prerecorded tape in the source unit.** If playback begins, press STOP on the unit.
- 3** The TV/VCR will record your tape. **Insert a blank tape in the TV/VCR.** Make sure the tape's record tab is intact and the TV/VCR is on.
- 4** Point the TV/VCR remote control at the TV/VCR. Press Number buttons 0, 0 so that **AUX** appears on the screen. The TV/VCR is now in Line Input or Auxiliary mode.
- 5** Point the TV/VCR remote control at the TV/VCR. Press SPEED until the desired tape speed (SP or SLP) appears on the screen.
- 6** Press PLAY on the source unit and REC(ord)/OTR on your TV/VCR at the same time. Copying will begin.
- 7** To stop copying, press STOP/EJECT on the TV/VCR, then stop the tape on the VCR or Camcorder.

Helpful Hints

- *Unauthorized recording of copyrighted television programs, video tapes, or other materials may infringe on the rights of copyright owners and violate copyright laws.*
- *Different brands of equipment may operate differently.*
- *Make sure all connections are secure. Otherwise, you may not record both picture and sound.*
- *Programs that are copyright protected may not record clearly.*
- *Tape speed details are on page 10.*

One-Touch Recording 27

A One-Touch Recording (OTR) is an immediate timed recording from 30 minutes to eight hours long.

- This function cannot be done from the remote control.
- Recording starts immediately when you press REC/OTR.

Before you begin, make sure ...

- The TV/VCR power is on and has a videotape with a record tab.
- If necessary, rewind or fast forward the tape to the point at which you want to begin recording.

1 Press the Number buttons or CH(annel) ▲/▼ to select the channel you want to record. Remember, if the TV/VCR is connected to a Cable Box or Satellite Receiver, the TV/VCR must be on channel 3 or 4. Select the channel you want to record at the Cable Box/Satellite Receiver.

2 Press SPEED to select a tape speed (SP/ SLP). Details are on page 10.

3 Press REC/OTR on the front of the TV/VCR to select a recording length. Each press of REC/OTR will increase the recording time by 30 minutes. You may select a maximum recording length of eight hours.

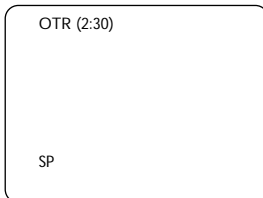

When recording finishes, the TV/VCR will turn itself off.

4 To stop an OTR before it ends on its own, press STOP/▼.

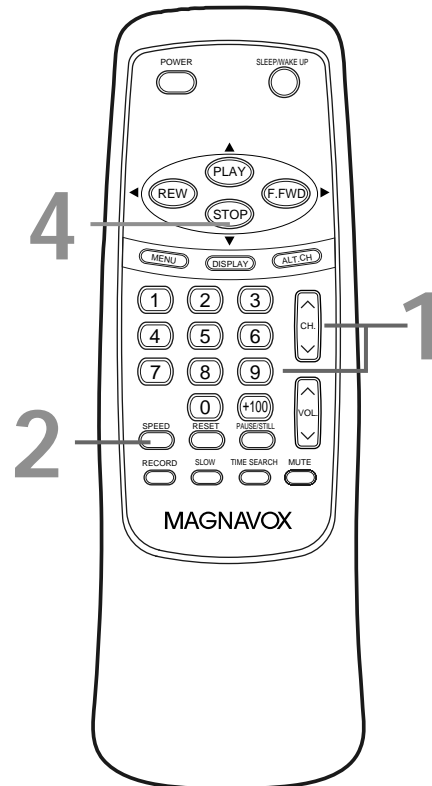

3 Press REC/OTR on the front of the TV/VCR.

Helpful Hints

- To show the remaining time, press DISPLAY. OTR and the remaining recording time will appear briefly.
- The maximum recording time of a T-160 tape in SLP speed is 8 hours (assuming you start at the beginning of the tape). A T-120 tape has a maximum of 6 hours recording time in SLP speed.
- If the tape ends before the recording's end time, the TV/VCR will stop recording, eject the tape, and turn itself off.
- You can turn off the TV/VCR during an OTR. The recording will continue at the length you set.

28 Playback Options

Forward and Reverse Searching (SP/LP/SLP)

- 1 During tape playback, press and release **F.FWD/▶** or **REW(ind)/◀**. A fast forward or reverse picture search will begin. Some horizontal noise lines may appear.
- 2 To return to normal play, press **PLAY/▲**.

High Speed Searching (LP/SLP)

- 1 During tape playback, press **F.FWD/▶** or **REW(ind)/◀**, then press again. The TV/VCR will search the tape in high speed. Some horizontal noise lines may appear. Press **F.FWD/▶** or **REW(ind)/◀** repeatedly to switch between regular and high speed searching.
- 2 To return to normal play, press **PLAY/▲**.

Viewing a Still Picture

- 1 During tape playback, press **PAUSE/STILL**. A still picture will appear on the screen. Press **PAUSE/STILL** repeatedly to advance the picture one frame at a time. Press **CH(annel) ▲/▼** to steady the still picture.
- 2 To release the still picture and return to normal play, press **PLAY/▲**.

Viewing a Slow Motion Picture

- 1 During tape playback, press **SLOW**. The tape will play in slow motion. Reduce noise lines by pressing **CH(annel) ▲/▼**.
- 2 To release Slow mode and return to normal play, press **PLAY/▲**.



Helpful Hints

- Still and Slow modes will switch to Stop mode after five minutes to protect the TV/VCR and the tape from damage.
- SP/LP/SLP means this feature will work with tape segments recorded in Standard Play, Long Play, or Super Long Play. LP/SLP means this feature will work with segments recorded in Long Play and Super Long Play. For details on tape speed, see page 10.
- Tapes recorded in SP will have fewer noise lines during searching.
- This TV/VCR will only record tapes in SP or SLP. It will play tapes that were recorded in LP on a different device (another VCR, for example).

Repeat Play 29

Repeat Play allows you to play a tape repeatedly.

- 1** Press **MENU**. Press **PLAY/▲** or **STOP/▼** to select **USER'S SET UP**. Then, press **F.FWD/▶**.

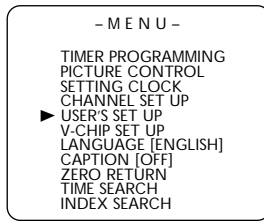

- 2** Press **PLAY/▲** or **STOP/▼** to select **REPEAT PLAY**. Press **F.FWD/▶** or **REW/◀** until **ALL** or **BLANK** appears. Choose **ALL** if you want to play tapes repeatedly from beginning to end. Choose **BLANK** to repeatedly play tapes from the beginning until the first blank portion of 10 seconds or more. Choose **OFF** to cancel Repeat Play.

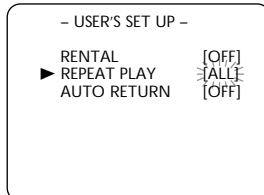

- 3** Press **MENU** to remove the menu.
- 4** Press **PLAY/▲** to start tape playback. **REPEAT PLAY ▶** appears briefly on the screen each time you start play.

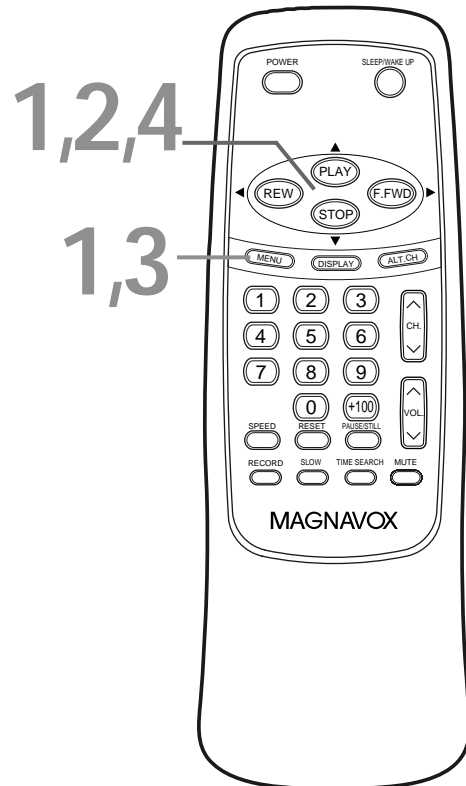

Helpful Hints

- Once you set Repeat Play, it stays in effect even after you turn off the TV/VCR. You must set it to OFF to disable it again.
- If RENTAL is ON, the RENTAL PLAY ▶ message has priority when you start playback. (REPEAT PLAY ▶ will not appear when you start playback.) Details are on page 30.
- The TV/VCR keeps the Repeat Play setting if the power fails.

30 Rental Playback, Zero Return

Rental Playback

This function improves the picture quality of worn videotapes.

- 1 Press MENU. Press PLAY/▲ or STOP/▼ to select USER'S SET UP. Then, press F.FWD/▶.

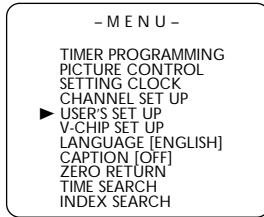

- 2 Press PLAY/▲ or STOP/▼ to select RENTAL. Press F.FWD/▶ or REW/◀ until ON appears. To cancel Rental Play, choose OFF.

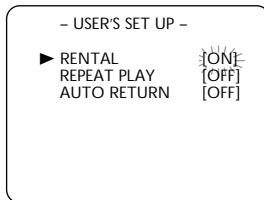

- 3 Press MENU to remove the menu.
- 4 Press PLAY to start playback. RENTAL PLAY ▶ appears briefly every time you start playback while RENTAL is ON.

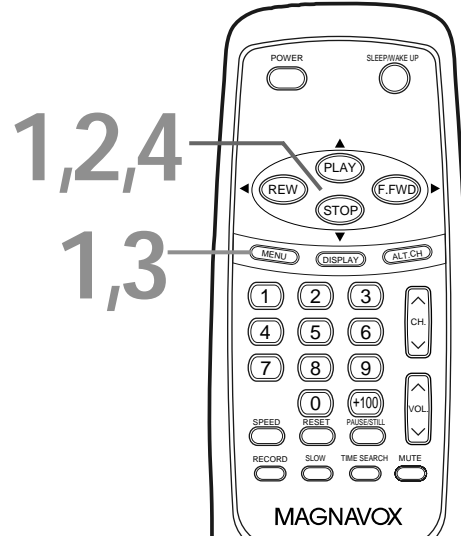

Zero Return

Set the tape counter to zero at a location you want to reach later.

- 1 Play, rewind, or fast forward the tape to the location you would like to refer to later. Press STOP/▼ to stop the tape.
- 2 Press RESET to set the counter to 0:00:00.
- 3 To return to this point, press MENU. Press PLAY/▲ or STOP/▼ to select ZERO RETURN. Then, press F.FWD/▶.

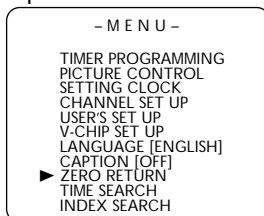

The tape counter will appear on the screen. When the tape reaches the point at which you set the counter to zero, the tape will stop. Press PLAY/▲ to watch the tape.

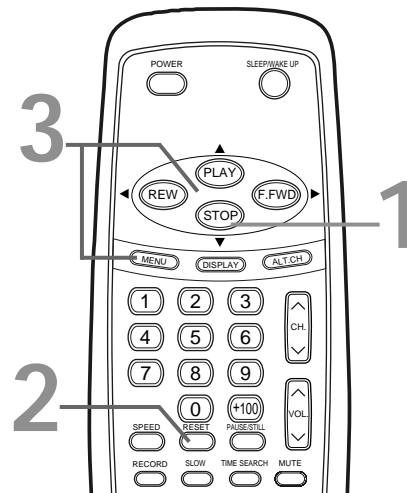

Helpful Hint

- The TV/VCR retains the Rental setting if the power fails or you turn off the TV/VCR.

Time Search, Index Search 31

Time Search

Time Search lets you rewind or fast forward a tape to a position by entering the amount of time you want to skip. Time Search is not available during recording.

- 1 When a tape is in the TV/VCR, press **TIME SEARCH**.
- 2 Press **PLAY/▲** or **STOP/▼** until your length of time appears (for example, 2:50 for 2 hours, 50 minutes). Each press changes the time by 10 minutes. Time Search can be set up to a maximum of 9 hours, 50 minutes (9:50) in 10-minute increments. To cancel the Time Search at this point, press **MENU**.

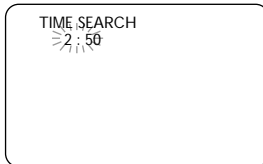

- 3 Press **REW/◀** or **F.FWD/▶**. The TV/VCR will rewind or fast forward the tape by the specified amount of time. The time counts down on the screen as the search progresses. When 0:00 is reached, the tape will play automatically. Or, to cancel the time search before it finishes, press **STOP/▼**.

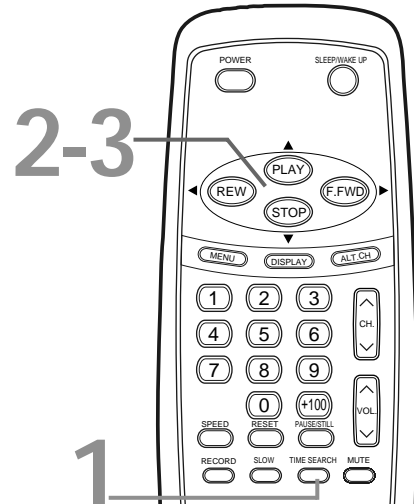

Index Search

Indexing marks the starting points of programs when you make a recording so you can easily rewind or fast forward to that point.

- 1 Press **MENU**. Press **PLAY/▲** or **STOP/▼** to select **INDEX SEARCH**. Then, press **F.FWD/▶**.

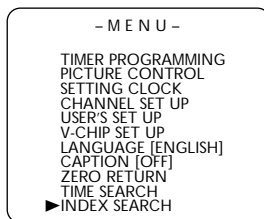

- 2 Press **PLAY/▲** or **STOP/▼** to select the number of programs you want to skip.
- 3 Press **F.FWD/▶** or **REW/◀** to start the **Index Search**. To search forward, press **F.FWD/▶**. To search backward, press **REW/◀**. When the search is complete, the tape will start to play automatically.

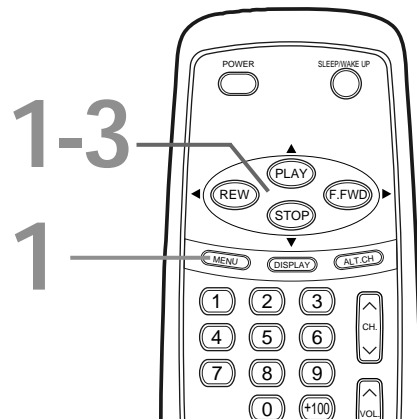

Helpful Hints

- A Time Search may not operate correctly if blank tape portions are encountered.
- If the end of the tape is reached during a search, the TV/VCR may rewind and eject the tape, then turn off.
- Index marks at the beginning of a videotape might not be detected.

32 Setting V-Chip

V-CHIP enables parents to prevent their children from watching inappropriate material on TV.

V-CHIP reads the ratings for programming (except for news and sports programs, unedited movies on premium cable channels, and Emergency Broadcast System signals), then denies access to programming if the program's rating meets or exceeds the limitations you select. In this case, the message PROTECTED PROGRAM by ... appears on the TV screen. The viewer must select a different TV channel or watch a videotape instead.

V-CHIP also blocks viewing of tapes that you record on this TV/VCR, if the recorded TV program's rating exceeds your V-CHIP settings.

Programming may be rated by the Motion Picture Association of America (MPAA) or according to the Television Parental Guidelines. In order to block any inappropriate programming, set your limits in both places (MPAA Rating and TV Rating).

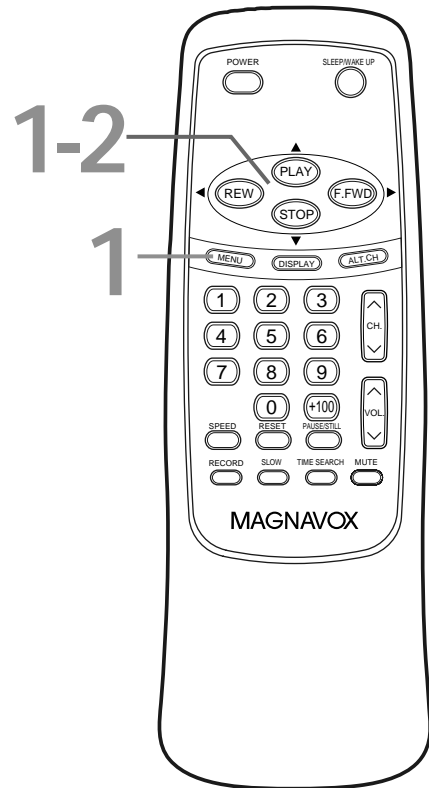

TV Rating Settings

- 1 Press MENU. Press PLAY/▲ or STOP/▼ to select V-CHIP SET UP. Then, press F.FWD/▶.

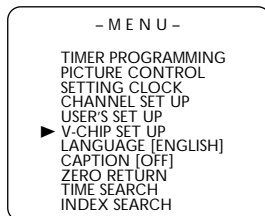

- 2 Press PLAY/▲ or STOP/▼ to select TV RATING. Then, press F.FWD/▶.

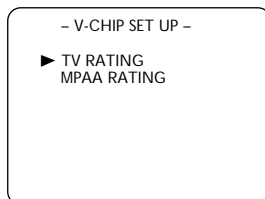

Instructions continue on the next page.

TV Rating Explanations

- V - Violence
- S - Sexual situations
- L - Language
- D - Inappropriate dialog
- FV - Fantasy Violence may frighten children under seven; TV-Y7 category only. Some cartoons may have this rating.
- TV-Y - Appropriate for all children
- TV-Y7 - Appropriate for children seven and older
- TV-G - General Audience
- TV-PG - Parental Guidance suggested.
- TV-14 - Unsuitable for children under 14
- TV-MA - Mature audience only

- 3** Press **PLAY/▲** or **STOP/▼** to select a rating.
Press **F.FWD/▶** to select **BLOCK** or **VIEW**.

| | | |
|--------|-----|--------|
| ▶ TV-Y | () | [VIEW] |
| TV-Y7 | () | [VIEW] |
| TV-G | () | [VIEW] |
| TV-PG | () | [VIEW] |
| TV-14 | () | [VIEW] |
| TV-MA | () | [VIEW] |

If you select TV-Y7, TV-PG, TV-14, or TV-MA, then press **F.FWD/▶** to select **BLOCK**, the selected category's subratings will appear. Press **F.FWD/▶** again to go to the next menu and set each subrating to **BLOCK** or **VIEW**. To set the subratings individually:

- **When you select TV-Y7:**

Press **PLAY/▲** or **STOP/▼** to select **FV** (Fantasy Violence), then press **F.FWD/▶** to select **BLOCK** or **VIEW**.

| | |
|-------|---------|
| TV-Y7 | [BLOCK] |
| ▶ FV | [BLOCK] |

- **When you select TV-PG, TV-14, or TV-MA:**

Press **STOP/▼** or **PLAY/▲** to select **D** (Suggestive Dialog), **L** (Coarse Language), **S** (Sexual Situations), or **V** (Violence). Then, press **F.FWD/▶** to select **BLOCK** or **VIEW**.

If you set the category (TV-PG, TV-14, or TV-MA) to **BLOCKED** or **VIEW** while in this menu, all the subratings also change to **BLOCK** or **VIEW** automatically.

| | |
|-------|---------|
| TV-PG | [BLOCK] |
| ▶ D | [BLOCK] |
| L | [BLOCK] |
| S | [BLOCK] |
| V | [BLOCK] |

- 4** Press **MENU** to remove the menu.

When you select VIEW for TV-Y, all other ratings will be available for viewing. This effectively turns off all V-CHIP censoring so you can watch all TV programming.

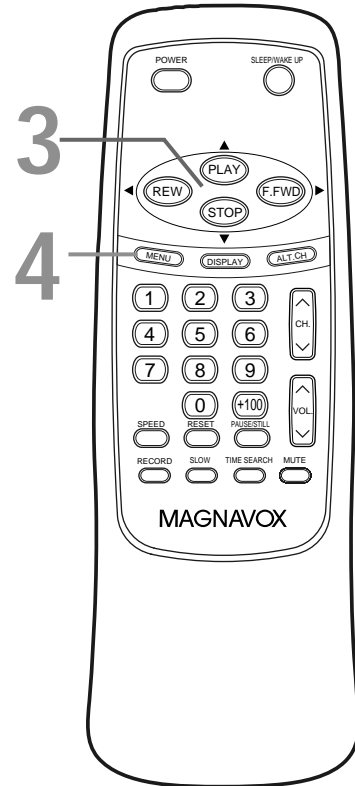

Helpful Hints

- When you select a rating category and choose **BLOCK**, the higher categories will automatically be blocked as well. The lower categories will be available for viewing.
- The **D** (dialog) subrating is not available for TV-MA.
- Subratings that are set to **BLOCK** appear next to the rating category in the TV RATING menu.

34 Setting V-Chip (cont'd)

MPAA Rating Settings

- 1** Press MENU. Press PLAY/▲ or STOP/▼ to select V-CHIP SET UP. Then, press F.FWD/▶.

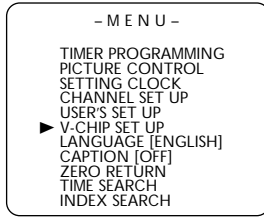

- 2** Press PLAY/▲ or STOP/▼ to select MPAA RATING. Then, press F.FWD/▶.

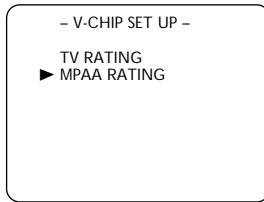

- 3** Press PLAY/▲ or STOP/▼ to select a rating. Press F.FWD/▶ to select BLOCK or VIEW. When you select a rating and choose BLOCK, the higher ratings will be blocked automatically. The lower ratings will be available for viewing.

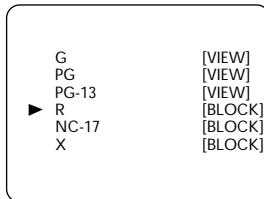

- 4** Press MENU to remove the menu.

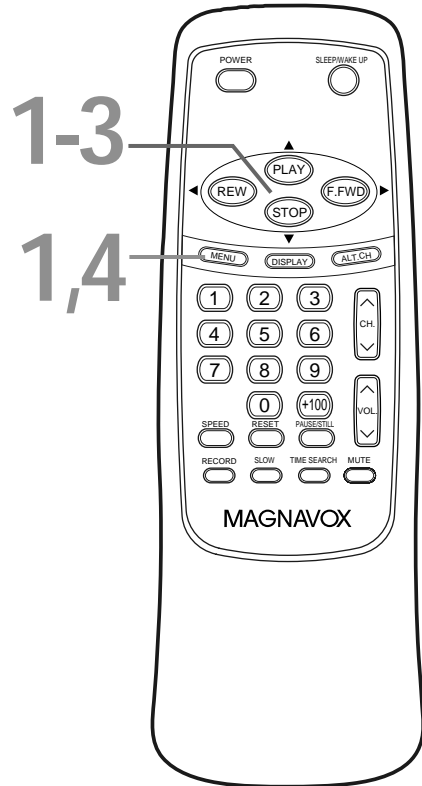

When you select VIEW for G, all other ratings will be available for viewing. This effectively turns off all V-CHIP censoring so you can watch all TV programming.

MPAA Rating Explanations

- G - General Audience
- PG - Parental Guidance suggested.
- PG-13 - Unsuitable for children under 13
- R - Restricted; under 17 requires accompanying parent or adult guardian
- NC-17 - No one under 17 admitted
- X - Mature audience only

Closed Caption 35

Follow the steps below to select closed captions for TV programming. Not all TV programs and commercials have closed captions or all types of closed captions (second language, half-screen text, etc.). If closed captioning is not broadcast, you cannot receive it. This does not indicate a problem with the TV/VCR. Check your TV program listings for shows with closed captions.

If the TV/VCR receives poor quality television signals, the captions may contain errors, or there might be no captions at all. Some possible causes of poor quality signals are:

- Automobile ignition noise
- Electric motor noise
- Weak signal reception
- Multiplex signal reception (ghosts or screen flutter)
- Playback of poorly recorded or worn videotapes.

1 Press **MENU**. Press **PLAY/▲** or **STOP/▼** to select **CAPTION**.

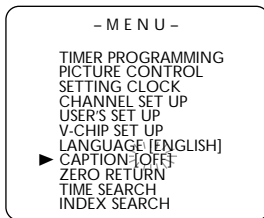

2 Press **F.FWD/▶** or **REW/◀** to select **CAPTION1**, **CAPTION2**, **TEXT1**, **TEXT2**, or **OFF**.

CAPTION1 displays standard closed captions (what a character is saying). CAPTION2 displays foreign language closed captions (foreign language words showing what a character is saying).

TEXT1 and TEXT2 display half-screen text (such as a channel guide, schedule, or announcement).

OFF turns off closed captions. Captions will not appear on the screen.

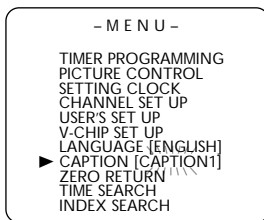

3 Press **MENU** to remove the menu.

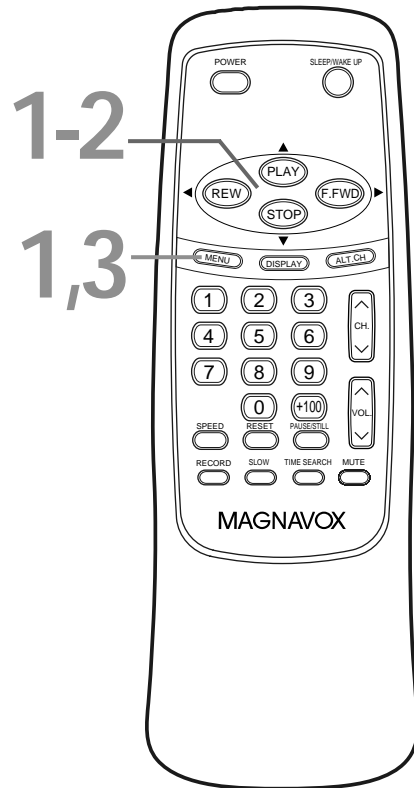

Helpful Hints

- If a black box appears on the TV screen, a **TEXT** mode is selected. To clear the screen, select **CAPTION1**, **CAPTION2**, or **OFF**.
- When Closed Captions are on, the on-screen display will disappear after five seconds. Closed captions disappear while the on-screen display is present.
- The TV/VCR retains the Closed Caption setting if the power fails.
- Abbreviations, symbols, and other grammatical shortcuts may be used in order to keep pace with the on-screen action. This is not a problem with the TV/VCR.
- Changing channels may delay closed captions for a few seconds.
- Adjusting or muting the volume may delay closed captions for a few seconds.

36 Wake Up Timer

The Wake Up Timer turns on the TV/VCR automatically at a specified time within the next 24 hours. You may set the TV/VCR to turn on at a TV channel or with VCR playback.

Before you begin:

- Set the clock. *Details are on pages 16-19.* If the clock is not set, you cannot set the Wake Up Timer.
- Put a tape in the TV/VCR if you want to play a tape at the specified time.

- 1 Press **SLEEP/WAKE UP** until **WAKE UP TIMER** appears.

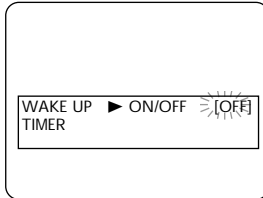

- 2 Press **F.FWD/▶** or **REW/◀** until **ON** appears.

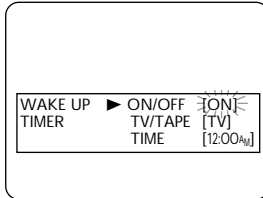

- 3 Press **PLAY/▲** or **STOP/▼** to select **TV/TAPE**. Press **F.FWD/▶** or **REW/◀** to select **TV** or **TAPE**. If you select TV, the current TV channel will be on when the TV/VCR turns on. Select TAPE to start tape playback when the TV/VCR turns on.

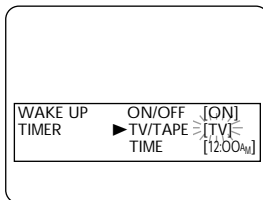

- 4 Press **PLAY/▲** or **STOP/▼** to select **TIME**. Press **F.FWD/▶** or **REW/◀** to select your wake up time.

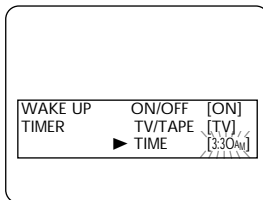

- 5 Press **MENU** to remove the menu. Press **POWER** to turn off the TV/VCR. The TV/VCR will turn on at the specified time.

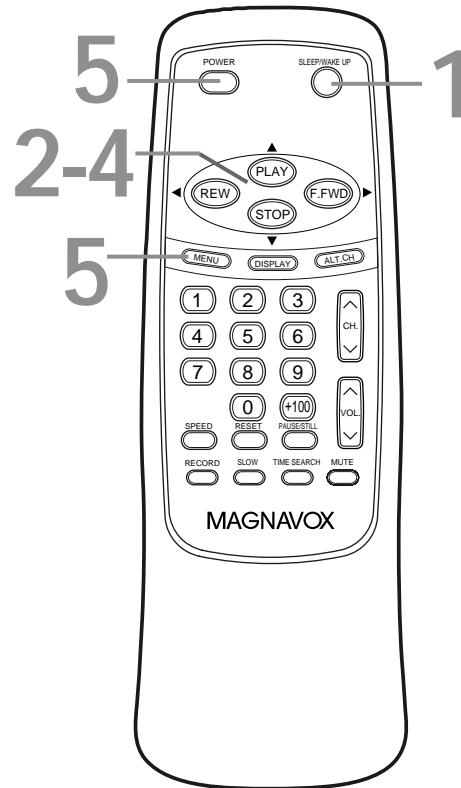

Helpful Hint

- To cancel the Wake Up Timer, press **SLEEP/WAKE UP** until **WAKE UP TIMER** appears, then press **F.FWD/▶** or **REW/◀** until **OFF** appears.

Sleep Timer 37

Use the Sleep Timer to program the TV/VCR to shut itself off in a certain amount of time.

- 1** Press **SLEEP/WAKE UP** until **SLEEP TIMER** appears.
- 2** Press **PLAY/▲**, **STOP/▼**, **F.FWD/▶** or **REW/◀** until your desired sleep time appears. You may choose 30 minutes, one hour, an hour and a half, or two hours.

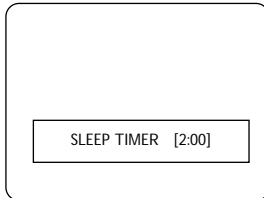

- 3** Press **MENU** to remove the Sleep Timer display.

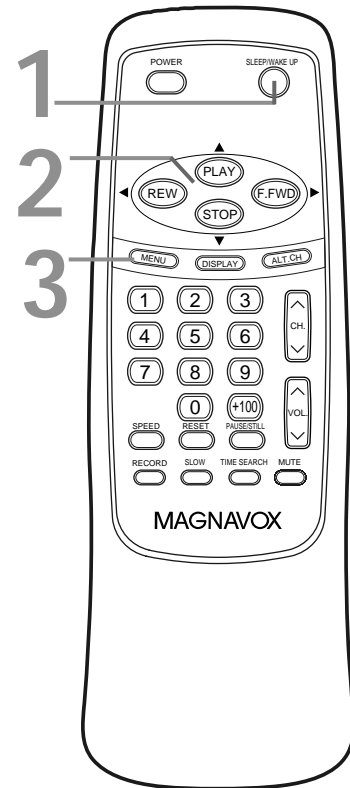

Helpful Hints

- To cancel the Sleep Timer, press **SLEEP/WAKE UP** until **SLEEP TIMER** appears. Press **PLAY/▲**, **STOP/▼**, **F.FWD/▶**, or **REW/◀** to select **OFF**. Press **MENU** or **SLEEP/WAKE UP** to remove the Sleep Timer display.
- To see how much time remains before the TV/VCR turns itself off, press **SLEEP/WAKE UP** twice. The time remaining appears in the [] beside **SLEEP TIMER**. Press **MENU** to remove the information.

38 Automatic Operation Features

Automatic Playback

When you put a tape in the TV/VCR, the power will come on automatically. If the tape's record tab is missing, playback will begin. If a timer recording is set, the power will not come on automatically when you insert a tape with the record tab intact. If a timer recording is set and the TV/VCR power is off, the TV/VCR will eject the tape if the record tab is missing.

Automatic Rewind, Eject, Off

When you play, fast forward, or record a tape to its end, the TV/VCR will rewind the tape, stop, turn itself off, and eject the tape.

Tape Eject

A tape can be ejected with the TV/VCR power on or off (but the TV/VCR must be plugged in). If a timer recording is programmed, a tape cannot be ejected when the power is off. In this case, turn on the TV/VCR power, then eject the tape. Be sure to insert a tape and turn off the TV/VCR power for the timer recording.

Automatic Tracking Adjustment

The TV/VCR automatically adjusts the tracking to give you the best possible picture quality. With some recordings, you may get a better picture using manual tracking.

Manual Tracking

To adjust the tracking manually, press the CHANNEL ▲/▼ buttons on the TV/VCR or the CH(annel) ▲/▼ button on the remote control during playback.

Tracking returns to Automatic Tracking Adjustment when you insert a tape or press STOP/▼.

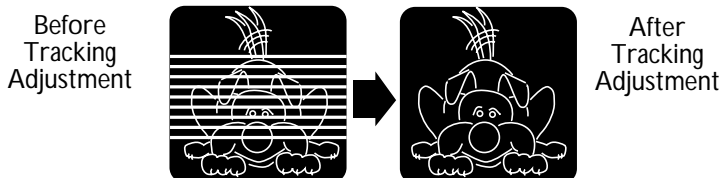

AUDIO In Jack: jack on the front of the TV/VCR that receives audio from other equipment.

Automatic Channel Setup: process in which the TV/VCR memorizes all available channels. Then, when you push the CH(annel) ▲/▼ button, you only scan through channels you receive.

Auxiliary (AUX): The channel to which you set your TV/VCR during dubbing or when viewing material that is playing on another device that is connected to the TV/VCR (for example, a Camcorder or VCR). The auxiliary (or line input) channel is always channel 00 (AUX).

Bands: settings that allow you to tune channels.

- **Antenna** – VHF (very high frequency; channels 2-13) and UHF (ultra high frequency; channels 14-69).
- **Cable** – standard channels 1-125 can be received without a Cable Box.

Bright: adjusting increases or decreases the brightness of the color on the screen.

Color: adjusting pales or brightens the picture color.

Contrast: the distinction between the black and white parts of the picture.

Dubbing: copying a tape using a separate VCR.

HQ: high quality; a circuitry feature that improves picture detail.

Mode: a TV/VCR operation.

OTR: One-Touch Recording; a timed recording that starts immediately and records for 30 minutes to eight hours, whichever you specify.

Sharpness: adjusting softens or clarifies the picture on the screen.

Tape Speeds: how fast the tape travels during playback or recording.

- **SP** (standard play) – fastest tape speed (recording time for a T120 tape is approximately two hours); best picture quality.
- **LP** (long play) – average tape speed; playback only.
- **SLP** (super long play) – slowest tape speed (recording time for a T120 tape is approximately six hours). Allows the most recording time to fit on a videotape.

Tint: adjusting changes the tints of the picture from red/purple to yellow/green.

VIDEO In Jack: jack on the front of the TV/VCR that receives video from other equipment.

40 *Helpful Hints*

Location

For safe operation and satisfactory performance of your TV/VCR, remember the following:

- Shield it from direct sunlight and keep it away from sources of intense heat.
- Avoid dusty or humid places.
- Avoid places with insufficient ventilation. Do not block the vents on the TV/VCR. Do not place the TV/VCR on a carpet, as this will block the vents.
- Avoid locations subject to strong vibrations.
- Do not place the TV/VCR near strong magnetic fields.
- Do not move the TV/VCR suddenly from a cold place to a hot place, or vice versa.

Electrical Shock and Fire Hazards

- Do not handle the power cord with wet hands.
- Do not pull the power cord when disconnecting it from the power outlet. Grasp it by the plug.
- If you spill water on the TV/VCR, unplug the power cord immediately and take the TV/VCR to an authorized service center.
- Do not put your fingers or objects into the TV/VCR cassette compartment.
- Do not place anything on top of the TV/VCR.

Dew Warning (Moisture Condensation)

- Moisture may condense inside the unit when you move it from a cold place to a warm place, after heating a cold room, or when the humidity is high. There is no warning that moisture is in your TV/VCR. Playing a tape in a TV/VCR in which moisture has accumulated could damage the tape and the TV/VCR. If you suspect moisture inside the TV/VCR, keep the TV/VCR power on (but do not play a tape) for at least two hours. This will allow the TV/VCR to dry.

TV/VCR will not perform a timer recording.

- Set the recording start and stop times correctly. *Details are on pages 22-24.* Midnight is 12 a.m. Noon is 12 p.m.
- Make sure the TV/VCR power is off before the recording's start time.
- Set the clock. *Details are on pages 16-19.*
- Put a tape in the TV/VCR. The tape must have a record tab.
- With ShowGuard, you don't have to worry about losing your timer recordings. If the power fails, timer recordings will be restored when the clock is reset. The timer recording will not occur if it was scheduled to take place during the power failure.

TV/VCR will not record.

- Make sure the tape has a record tab. *Details are on page five.*
- Plug the power cord into an active AC outlet. *Details are on page seven.*
- Check your hookups. *Details are on pages six-seven.*
- Set up the TV channels. *Details are on pages eight and 14.*

Channel reception is poor.

- Check connections, then set up the channels again. *Details are on pages eight and 14.*

TV/VCR has no power.

- Connect the power plug to an AC (alternating current) outlet completely.

TV/VCR ejects the tape when you try to start a recording.

- Make sure the tape has a record tab. *Details are on page five.*

The picture or color is faulty.

- Magnetism or geomagnetism from nearby equipment can affect the color in the TV picture. Move the TV/VCR away from other equipment, and the color will correct automatically. Or, unplug the power cord and reconnect it after 30 minutes.
- Adjust the TV/VCR picture controls. *Details are on page 21.*

Helpful Hints (cont'd) 41

The remote control is not available and you need to access the menu.

- Press CHANNEL ▲ or ▼ on the front of the TV/VCR to go to channel zero or AUX. Press CHANNEL ▲ once to access the TV/VCR menu. Use the PLAY, REW, F.FWD, and STOP/EJECT buttons on the front of the TV/VCR to go through the menu. Press CHANNEL ▲ on the front of the TV/VCR again to remove the menu and go to your lowest TV channel. (Press CHANNEL ▼ on the front of the TV/VCR again to remove the menu and go to AUX.) Some menus, such as TIMER PROGRAMMING or SETTING CLOCK, can be removed only by turning off the TV/VCR. *Details are on page 12.*

TV/VCR power shuts off after 15 minutes.

- The TV/VCR will shut itself off after 15 minutes when it is on a channel that is not receiving a broadcast signal (for example, a station that has gone off the air for the night). This is normal.

TV/VCR does not have a picture.

- Adjust the antenna or check the Cable TV signal. *Details are on page six.*
- Select an active channel.

TV/VCR has poor sound or no sound.

- Adjust the volume.
- Press the MUTE button to restore the volume.

Tape playback is poor or tape is destroyed.

- Adjust the tracking. *Details are on page 38.*
- Use the Rental feature. *Details are on page 30.*
- If moisture has accumulated in your TV/VCR, keep the power on for at least two hours, but do not try to play a tape. *Details are on page 40.*

TV/VCR does not display closed captions.

- Make sure closed captioning is available for the program. Refer to the TV listings in your local newspaper.
- Closed captions are available for TV programming only, not videotape playback. *Details are on page 35.*

Remote control does not operate TV/VCR.

- Aim the remote control directly at the remote sensor on the front of the TV/VCR. *Details are on page 12.*
- Remove all obstacles between the remote control and the TV/VCR.
- Inspect and replace the batteries in the remote control. *Details are on page five.*

Number buttons will not select channels above 69.

- Enter channel numbers as a two-digit number. If you want to select channels 100 and above, press the +100 button, then the Number buttons for the last two digits.
- If you are using an antenna and do not have Cable TV service, only channels 2-69 will be available.

You cannot insert a tape into the TV/VCR.

- Insert the videotape with the window side up, with the record tab facing you and to the left.
- Make sure a tape isn't already in the TV/VCR by pressing the STOP/EJECT button on the front of the TV/VCR.
- Gently push on the center of the tape. Never force a tape into the TV/VCR.
- If you have set a timer recording and the TV/VCR power is off, the TV/VCR will eject the tape if the record tab is missing.

You cannot remove the tape from the TV/VCR.

- Make sure the power plug is completely connected to a power outlet.
- If a timer recording is programmed, turn on the TV/VCR power, then eject the tape. Be sure to insert a tape and turn off the TV/VCR power for the timer recording.
- Unplug the TV/VCR power cord for five minutes. Plug in the power cord again, then press the POWER button on the TV/VCR. If the tape does not eject, press the STOP/EJECT button on the TV/VCR three to five times. If the tape still does not eject, you may need to have an authorized servicer remove the tape.

42 Specifications

General

CRT: 19-inch in line gun
Television system: NTSC
Closed caption system: Section 15.119, FCC
(Federal Communications Commission) Standard
Video Heads: Two heads
Tape width: 1/2 inch (12.65 mm)
Tape speed
 SP: 33.35 mm/sec.
 LP: 16.67 mm/sec.
 SLP: 11.12 mm/sec.
Operating Temperature: 41°F (5°C) to 104°F (40°C)
Relative Humidity: 10% to 75%
Power requirement: AC 120V, 60Hz
Power consumption: 80W
Sound output: 1W
Dimensions:
 19-3/4" (H) x 19-3/8" (W) x 18-3/4" (D)
 502 mm x 493 mm x 476 mm
Weight: 42.99 lbs (19.5 kg)

Tuner Broadcast Channels

VHF 2-13, UHF 14-69

Cable TV Channels

1-125

Terminals

Antenna In: VHF/UHF 75 ohms unbalanced
Video In: RCA connector
Audio In: RCA connector
Earphone: 3.5 mm CES

Electrical Specifications

Video input level: 0.5~2.0Vp-p
Audio input level: -10dBv
Video S/N ratio
 SP: More than 42dB μ
Audio S/N ratio
 SP: More than 38dB

Designs and specifications are subject to change without notice and without our legal obligation.

Limited Warranty 43

TV/VCR COMBINATION

90 Days Free Labor/One Year Parts Exchange
This product must be carried in for repair.

WHO IS COVERED?

You must have proof of purchase to receive warranty service. A sales receipt or other document showing that you purchased the product is considered proof of purchase.

WHAT IS COVERED?

Warranty coverage begins the day you buy your product. *For 90 days thereafter*, all parts will be repaired or replaced, and labor is free. *From 90 days to one year from the day of purchase*, all parts will be repaired or replaced, but you pay for all labor charges. *After one year from the day of purchase*, you pay for the replacement or repair of all parts, and for all labor charges.

All parts, including repaired and replaced parts, are covered only for the original warranty period. When the warranty on the product expires, the warranty on all replaced and repaired parts also expires.

WHAT IS EXCLUDED?

Your warranty does not cover:

- labor charges for installation or setup of the product, adjustment of customer controls on the product, and installation or repair of antenna systems outside of the product.
- product repair and/or part replacement because of misuse, accident, unauthorized repair or other cause not within the control of Magnavox.
- reception problems caused by signal conditions or cable or antenna systems outside the unit.
- a product that requires modification or adaptation to enable it to operate in any country other than the country for which it was designed, manufactured, approved and/or authorized, or repair of products damaged by these modifications.
- incidental or consequential damages resulting from the product. (Some states do not allow the exclusion of incidental or consequential damages, so the above exclusion may not apply to you. This includes, but is not limited to, prerecorded material, whether copyrighted or not copyrighted.)
- damage caused by the use of non-VHS tapes or tapes that have not been tested and labeled for use in two, four, six, and eight hour VHS recorders.
- a product that is used for commercial or institutional purposes.

WHERE IS SERVICE AVAILABLE?

Warranty service is available in all countries where the product is officially distributed by Magnavox. In countries where Magnavox does not distribute the product, the local Magnavox service organization will attempt to provide service (although there may be a delay if the appropriate spare parts and technical manual(s) are not readily available).

MAKE SURE YOU KEEP...

Please keep your sales receipt or other document showing proof of purchase. Attach it to this owner's manual and keep both nearby. Also keep the original box and packing material in case you need to return your product.

BEFORE REQUESTING SERVICE...

Please check your owner's manual before requesting service. Adjustments of the controls discussed there may save you a service call.

TO GET WARRANTY SERVICE IN U.S.A., PUERTO RICO, OR U.S. VIRGIN ISLANDS...

Take the product to a Magnavox factory service center (see enclosed list) or authorized service center for repair. When the product has been repaired, you must pick up the unit at the center. Centers may keep defective parts.

(In U.S.A., Puerto Rico, and U.S. Virgin Islands, all implied warranties, including implied warranties of merchantability and fitness for a particular purpose, are limited in duration to the duration of this express warranty. But, because some states do not allow limitations on how long an implied warranty may last, this limitation may not apply to you.)

TO GET WARRANTY SERVICE IN CANADA...

Please contact Magnavox at:

1-800-705-2000.

(In Canada, this warranty is given in lieu of all other warranties. No other warranties are expressed or implied, including any implied warranties of merchantability or fitness for a particular purpose. Magnavox is not liable under any circumstances for any direct, indirect, special, incidental or consequential damages, howsoever incurred, even if notified of the possibility of such damages.)

REMEMBER...

Please record below the model and serial numbers found on the product. Also, please fill out and mail your warranty registration card promptly. It will be easier for us to notify you if necessary.

MODEL # _____
SERIAL # _____

This warranty gives you specific legal rights. You may have other rights which vary from state to state.

44 Index

- alt.ch button11
- ant(enna) jack6, 13
- audio in jack7, 12, 26
- auto return25
- automatic
 - playback38
 - rewind38
- auxiliary mode (aux) 7, 12, 26, 39

- batteries5
- bright21

- cassette compartment12
- ch(annel) ▲/▼ button (remote)11, 38
- channel
 - above 1008
 - adding15
 - deleting15
 - setup8, 14
- channel ▲/▼ buttons (TV/VCR)12, 38
- clock16-19
- closed caption35
- color21
- connections6-7, 26
- contents, table of4
- contrast21
- controls
 - remote11
 - tv/vcr12

- daylight-savings time20
- display button11, 21
- duplication26

- earphone jack12
- ejecting a tape9, 38, 41

- fast forward search28
- f.fwd button (TV/VCR)12
- f.fwd/▶ button (remote) .11, 28
- front panel12

- glossary39

- helpful hints40-41
- high speed searching28
- hookups6-7, 26

- index search31

- language selection14
- long play (lp)10, 39
- lp (long play)10, 39

- menu access from front panel 12
- menu button11
- mute button11

- number buttons8, 11

- one-touch recording27

- pause/still button11, 28
- picture control21
- play button (TV/VCR)12
- play/▲ button (remote)11
- playback options28
- playing a tape9
- power button11-12
- power cord7, 13

- ratings
 - movie34
 - tv32-33
- rear panel13
- rec/otr button (TV/VCR) .12, 27
- record button (remote)11
- record light12
- recording10
- recording prevention5
- remote control11
- remote sensor12
- repeat play29
- rerecording26
- reset button11, 30
- rew(ind) button (TV/VCR) ..12
- rew(ind)/◀ button (remote)11, 28
- rewinding11, 28

- safety precautions3
- searching28, 31
- sensor (remote)12
- sharpness21
- sleep timer37
- sleep/wake up button .11, 36-37
- slow
 - button11, 28
 - motion playback28
- slp (super long play)10, 39
- sp (standard play)10, 39
- specifications42
- speed button10-11
- standard play (sp)10, 39
- status display21
- still picture28
- stop/▼ button11
- stop/eject button12
- super long play (slp)10, 39

- tape duplication26
- tape speed10, 39
- time search31
- time search button11, 31
- time setting16-19
- timer recording
 - cancelling24
 - setting22-23
- tint21
- tracking38

- v-chip setup32-34
- video in jack7, 12, 26
- vol(ume) ▲/▼ button (remote)11
- volume ▲/▼ buttons (TV/VCR)12

- wake up timer36
- warranty43

- zero return30



This owner's manual is made of recycled paper.



As an ENERGY STAR® Partner, Magnavox has determined that this product meets the ENERGY STAR® guidelines for energy efficiency. ENERGY STAR® is a U.S. registered mark.

IB8423E001
Printed In Malaysia
OEMN02165 / T7412UN * * * * *